

INTRAFORM PTY LTD

and

**the CFMEU (Victorian
Construction and General
Division)**

Subcontractors

**Concrete Kerb, Channel &
Pavement**

Enterprise Agreement

2024 – 2027

PART 1- APPLICATION AND OPERATION		6
1	Title	6
2	Definitions	6
3	Date and Period of Operation	8
4	Scope of Agreement	8
5	Relationship to the Award and the NES	10
6	First Nations People	11
7	Diversity and Inclusion	11
8	Objectives and Commitments	12
9	Severability	13
10	Flexibility Arrangements	13
PART 2 - DISPUTE RESOLUTION AND CONSULTATION		15
11	Disputes Resolution Procedure	15
12	Consultation	18
13	Flexibility Arrangements on Significant, Major or Unusual Projects	19
PART 3 - TYPES OF EMPLOYMENT AND TERMINATION OF EMPLOYMENT		21
14	Contract of Employment	21
15	Security of Employment	26
16	Use of Subcontractors	29
17	Visa Compliance	29
18	Notice of Termination	30
19	Additional Provisions	31
20	Redundancy	31
21	Industry fund compliance	31
22	Superannuation	32
23	LeavePlus (Long service leave)	33
24	Incolink	33
PART 4 - CLASSIFICATIONS AND MINIMUM WAGE RATES		38
25	Wage Rates	38
26	Allowances	38
27	Clothing Issue	43
28	Higher Duties	45

29	Payment of Wages	45
30	Wage Payment Details	45
31	Inclement Weather	47
32	Training and Related Matters Training and Related Matters	53
33	Licensed trades – recognition of prior learning	54
34	Accident Pay and Workers Compensation	55
	PART 5 - HOURS OF WORK AND RELATED MATTERS	56
35	Hours of Work	56
36	Shiftworkers	56
37	Rostered Days Off	57
38	Overtime	61
39	Breaks	63
	PART 6 - LEAVE AND PUBLIC HOLIDAYS	65
40	Annual Leave	65
41	Public Holidays	67
42	Personal and/or Carer’s Leave	68
43	Compassionate Leave	68
44	Community Service Leave (other than Jury Service)	69
45	Jury Service	69
46	Parental Leave	69
47	Family and Domestic Violence Leave	69
48	Picnic Day	70
	PART 7 - EMPLOYEE REPRESENTATION	72
49	Representation	72
50	Union Delegate Rights	72
51	Union Delegate/Employee Representative Facilities	73
52	Industrial Relations Training Leave	73
53	Tool Box Meetings	73
54	Right of entry	74
	PART 8 - SAFETY	76
55	Safety Objectives	76
56	Inductions	76

57	Electronic Site Access Control	77
58	Health and Safety Representatives	78
59	Health and Safety Representative Meetings	79
60	Procedure For Dealing with Safety Issues or Incidents	79
61	Site Safety Supervisor	81
62	Safety Committee	81
63	Training for Health and Safety Representatives	82
64	Personal Protective Equipment	82
65	Additional Safety provisions (Heavy Materials, Stand-By Drivers and Crane Crews)	82
66	Drug and Alcohol Policy	83
67	Drug and Alcohol Awareness Training	83
68	Safe and Respectful Workplace	83
	PART 9 - AGREEMENT MATTERS	85
69	Union Flag	85
70	Posting of Agreement	85
	PART 10 – SITE ISSUES	86
71	Amenities	86
72	Amenities for Females	88
73	Site Issues	89
	PART 11 – INDUSTRY MODERNISATION	90
74	Workplace Modernisation	90
75	Signatories	91
	APPENDIX A – Classification	92
	APPENDIX B – Wage Rates	94
	APPENDIX C – Site Allowance Procedure	98
	APPENDIX D – RDO Calendars	104
	APPENDIX E – Training Leave for Workplace Representatives.....	110
	APPENDIX F – Passenger and Material Lifts.....	114
	APPENDIX G – Drug and Alcohol Management Program.....	118
	APPENDIX H – Living Away From Home Allowance	141
	APPENDIX I – Notification Form Pursuant to Clause 37.8(c) to Work on Scheduled RDO	145

APPENDIX J – Sexual Harassment Principles	146
APPENDIX K – Flexible Working Arrangement Request Form	149
APPENDIX L – Sham Contracting Compliance Checklist	151
APPENDIX M – Preserved Award Allowances.....	155
APPENDIX N – Respect Code	164
APPENDIX O – Job Sharing Examples.....	170

PART 1- APPLICATION AND OPERATION

1 Title

- 1.1 This Agreement is known as the **INTRAFORM PTY LTD** and the CFMEU (Victorian Construction and General Division) Subcontractors Concrete Kerb, Channel & Pavement Enterprise Agreement 2024 - 2027 (the **Agreement**).

2 Definitions

- 2.1 In this Agreement:

Award means the *Building and Construction General On-site Award 2020* as varied from time to time;

CBUS means the Construction and Building Unions Superannuation Scheme;

Continuous service means the period of service of an Employee notwithstanding the Employee's absence from work for any of the following reasons:

- (a) annual leave, personal leave or parental leave;
- (b) illness or accident up to a maximum of four weeks after the expiration of paid sick leave;
- (c) any other authorised unpaid leave up to a maximum of four weeks;
- (d) jury service;
- (e) injury received during the course of employment and up to a maximum of 52 weeks for which the Employee received worker's compensation;
- (f) where called up for military service for up to three months in any qualifying period;
- (g) long service leave; and
- (h) any reason satisfactory to the Employer, provided the Employee has informed the Employer within 24 hours of the time when the Employee was due to attend for work, or as soon as practicable thereafter, of the reason for the absence and probable duration;

Continuous Shiftworker for the purpose of the additional week of annual leave provided by the NES means an Employee engaged to work in a system of consecutive shifts throughout the 24 hours of each of at least six consecutive days without interruption (except during breakdown or meal breaks or due to unavoidable causes beyond the control of the Employer) and who is regularly rostered to work those shifts;

DHA means the Department of Home Affairs, and its predecessor and successor (if any) agencies;

Disputes Panel/Panel means the Victorian Building Industry Disputes Panel;

Employee/s means an employee of the Employer who is a construction worker engaged in building and construction performing concrete kerb, concrete channel, concrete pavement, and associated works;

Employer means **INTRAFORM PTY LTD** ABN: **55 667 793 222**

Fair Work Act means the *Fair Work Act 2009* (Cth) as varied from time to time;

FWC means the Fair Work Commission;

HSR/ Health and Safety Representative means a member of a designated work group elected to represent the designated work group on matter relating to occupational health and safety;

Industry RTO means as defined in **clause 32.4**;

Ordinary Rate means the hourly rate of pay for the ordinary hours of work as listed in **Appendix B**;

Ordinary Time Earnings for all purposes in this agreement has the same definition as defined by *Superannuation Guarantee Ruling 2009/2*. Without limiting the fullness of this definition, in summary and in the context of this agreement, this includes:

- (a) wages and allowances earned in respect of ordinary hours of work (see **clause 35**) but excluding any wages and allowances earned in the performance of overtime; and
- (b) shift loading;

NES means the National Employment Standards prescribed by the Fair Work Act;

OHS Act/ Occupational Health and Safety Act means the *Occupational Health and Safety Act 2004* (Vic) as varied from time to time;

Party or Parties to this Agreement means the Employer, Employees and/or the Union as the context requires;

Project means building and construction works performed on a site or combination of sites for which:

- (a) the site or combination of sites must constitute an enterprise or undertaking carefully planned to achieve a particular result;
- (b) the site or combination of sites must have a clearly established entity or entities that exercise control over its development; and
- (c) the site or combination of sites must have a scope sufficiently definable at any given point during the project to enable its proper definition and costing for the purpose of determining the appropriate site allowance;

Project Value including **Total Project Value** means the value of the Project (as defined above), comprising of:

- (a) preliminary costs and profit margin;
- (b) trade packages (including supplier and subcontractor costs); and
- (c) provisional sums.

Project Value does not include non-construction development costs;

Redundancy means a situation where an Employee ceases to be employed by an Employer, other than for reasons of misconduct or refusal of duty. Redundant has a corresponding meaning;

RTO means a 'registered training organisation' registered on the State Register and National Register in accordance with the *Education and Training Reform Act 2006* (Vic) as varied from time to time;

Shiftwork means work comprising recurring periods in which different groups of workers do the same jobs in rotation. For the sake of clarity, the different groups of workers do not necessarily need to be employed by the same employer for the purpose of this definition;

Shiftworker means an Employee who performs Shiftwork in accordance with **clause 36**;

Union or CFMEU means the Construction, Forestry and Maritime Employees Union Construction and General Division, Victoria Tasmania Divisional Branch; or the Construction, Forestry and Maritime Employees Union, as the context requires; and

VEVO means the Department of Home Affairs, Visa Entitlement Verification Online system.

3 Date and Period of Operation

- 3.1 This Agreement will operate from the date seven (7) days after it is approved by the FWC and shall have a nominal expiry date of 2 July 2027. By no later than 2 July 2026 the Employer intends to commence discussions concerning a replacement enterprise agreement. This Agreement will continue to operate after its nominal expiry date unless it is replaced by another enterprise agreement or terminated in accordance with the Fair Work Act.

Note: where a date is specified for the commencement of a payment it is a reference to the first pay period on or after that date.

4 Scope of Agreement

- 4.1 This Agreement applies in the State of Victoria and covers:
- (a) the Employer;
 - (b) Employees who are construction workers engaged in the on-site building, engineering and civil construction industry as defined in the Award, performing concreting and associated works for installation of concrete kerb, concrete channel and concrete pavement; and
 - (c) the Union, subject to the operation of section 201(2) of the Fair Work Act; but
 - (d) construction work in the cottage/housing industry shall not fall within the scope of this Agreement. For the purposes of this Agreement, cottage/housing industry means the construction, erection, assembly, maintenance ornamentation or demolition of a single occupancy dwelling and multiple occupancy residential units being of not more than two living levels height.
 - (e) This Agreement does not cover the Employer and its employees who subsequently enter into and are covered by a project specific enterprise agreement for one of the Big Build Projects referred to in clause 4.5.
- 4.2 For Employees performing work on an apartment building between two (2) and four (4) living levels height above ground (inclusive), the express provisions of

this Agreement will not apply except those listed in the table below, instead the incorporated Award terms will apply.

Clause Number	Description
Clause 1	Title
Clause 2	Definitions
Clause 3	Date and Period of Operation
Clause 4	Scope of Agreement
Clause 5	Relationship to the Award and the NES
Clause 10	Flexibility Arrangements
Clause 11	Dispute Resolution Procedure
Clause 12	Consultation
Clause 22.2	Default Superannuation Fund
Clause 25	Wage Rates
Clause 35	Hours of Work
Clause 45	Jury Service

- 4.3 Where **clause 4.2** does not apply, for Employees performing work on apartment buildings that have greater than four living levels height above ground with a Project Value of \$50M or less or community, education, health, refurbishment and not for profit facilities that have a Project Value of \$25M or less, for Projects outside the City of Melbourne as defined in Appendix C, the following listed clauses of the Award will apply in lieu of the following listed clauses of this Agreement:

Award clauses that apply	Agreement clauses that do not apply
28 – Superannuation	22.3 and 22.6 – (part of Superannuation)
26.1 – Fares and Travel Patterns Allowance	26.7 - Daily Fares and Travel Pattern Allowance
25 – Living Away from Home – Distant Work	Appendix H - Living Away From Home Allowance
17 – Shiftwork	36 – Shiftworkers
29 – Overtime	38 – Overtime
21.2 Meal Allowance	38.4 - Overtime meal allowance

- (a) Where the Project Value is less than \$50m it does not mean that the clauses of this Agreement do not apply. The intent of this clause is not for a larger Project to be split into smaller values in order to implement the flexibilities of this clause. In implementing this clause the Employer must give consideration to the Project as a whole (including existing and future packages of work).
- (b) The Parties recognise that Projects with a Project Value of less than \$50 million, by their nature may require the implementation of some alternative work practices. In addition to compliance with this Agreement, it is recognised that consultation between the Employer and the Union should occur in order to plan the application of alternative work practices.

4.4 The Employer and affected Employees and any representative(s) of their choice, will consult on these smaller Projects over workforce composition, efficient work practices and workforce mobility, whilst remaining committed to the highest levels of workplace safety. The consultation may include, but is not limited to:

- (a) three person crane crew;
- (b) a crane crew on site only when required;
- (c) use of a contract cleaner in lieu of a peggy; and
- (d) multi-tasked roles for Employees.

4.5 **Specified Projects**

- (a) The Parties recognise the unique nature of the Victorian Government 'Big Build' Projects. To this end, where:
 - (i) an Employee is engaged by the Employer on one of the following major projects:
 - (A) North East Link Project;
 - (B) Suburban Rail Loop Project; or
 - (C) Airport Rail Link Project;
- (Big Build Projects)**

and

- (ii) the wages and conditions under the project specific enterprise agreement (covering the Principal Contractor or any associated entities through which it engages labour for the Big Build Project) on the Big Build Project are higher than those provided in this Agreement;

then

- (b) the Employee, whilst performing work on the Big Build Project, will receive the higher wages and conditions (reflected in the project specific enterprise agreement) in accordance with their respective classification under this Agreement.

5 Relationship to the Award and the NES

5.1 Subject to this clause, the Award is incorporated into and forms part of this Agreement.

- 5.2 If there is any inconsistency between an express term of this Agreement and an incorporated Award term, the express term of the Agreement will prevail to the extent of any inconsistency.
- 5.3 For the sake of clarity, the Appendices to this Agreement, including the Preserved Award Allowances contained in Appendix M operate as terms of this Agreement. Eligibility for receipt of the respective allowances listed in Appendix M are as per the terms of the *Building and Construction General On-Site Award 2010* as it stood at 19 December 2019.
- 5.4 This Agreement will be read and interpreted in conjunction with the NES. Where there is an inconsistency between this Agreement and the NES, and the NES provides a greater benefit, the NES provision will apply to the extent of the inconsistency.

6 First Nations People

- 6.1 The Employer, Employees and the Union recognise the First Nations People in the State of Victoria as the Traditional Owners of the Land.
- 6.2 The Employer will ensure that an acknowledgement of Traditional Owners of the Land will be made on every Project. All Employees will receive cultural awareness information as part of the site induction process to ensure that all workers are made aware of the history and spiritual connection that Traditional Owners have with the area where the Project is being constructed.
- 6.3 A 'Welcome to Country' ceremony may be arranged with the Traditional Owners to demonstrate the Employer's commitment to the principles of social, restorative justice and cultural affirmation.
- 6.4 At every Project where the Employer is the principal contractor, it will, in consultation with the Union's Indigenous/First Nations Officer and First Nations Employees, install an Acknowledgement of Country at the main site entry or an alternative agreed location on site.
- 6.5 **First Nations Employees**
- (a) The Parties to this Agreement acknowledge the Office of the Registrar of Indigenous Corporations (**ORIC**) as an established office holder appointed by the Minister for Indigenous Affairs under the Corporations (Aboriginal and Torres Strait Islander) Act 2006 (CATSI Act).
- (b) The Employer will recognise any Employee who provides evidence endorsed by Aboriginal and Torres Strait Islander traditional owners of lands as recognised by ORIC as a First Nations Employee for the purposes of this Agreement.

7 Diversity and Inclusion

- 7.1 Consistent with the values of the Employer, the Parties to this Agreement recognise the importance of investing for the future and creating a flexible and inclusive workplace where diversity is embraced and supported.
- 7.2 The Parties agree that creating an accessible work environment that facilitates flexible and inclusive work practices and strategies around the attraction, engagement and retention of Employees, who represent the communities within which we operate, is important.
- 7.3 The Employer, Employees and the Union recognise the importance of fair and inclusive treatment of all people, irrespective of gender.

- 7.4 The provisions of this Agreement are to be gender neutral and gender inclusive.
- 7.5 All pronouns used in this Agreement, whether used in the masculine, feminine or neuter gender shall include all other genders, and the singular shall include the plural and vice versa.
- 7.6 The Employer will ensure that equal opportunities for recruitment, career growth and development are provided to all Employees, irrespective of gender.

8 Objectives and Commitments

- 8.1 The Objectives of the Parties to this Agreement are:
- (a) to promote fair, cooperative and productive workplace relations in the building and construction industry;
 - (b) to provide a detailed set of agreed employment benefits, conditions, rights and obligations via direct employment with the Employer;
 - (c) to explore the potential for innovation and new technologies;
 - (d) to consider any benefits of alternative hours of work;
 - (e) to support the establishment of consultative bodies to consider the impact of climate change on the working conditions in the industry;
 - (f) to establish practices that support opportunities for a diversified workforce;
 - (g) to support the implementation of highest possible levels of OHS practices, procedures and training;
 - (h) to ensure that fair and equitable employment practices are applied in the workplace;
 - (i) to improve efficiency in the workplace;
 - (j) to provide for the establishment and observance of an effective disputes settlement procedure that involves Employees and their representatives, when requested, at the earliest stage of any dispute or potential dispute.
- 8.2 The Parties to this Agreement commit themselves to ensuring that:
- (a) the efficiency measures contained in this Agreement are implemented and lead to real gains in productivity.
 - (b) the principles of industry modernisation are realised during the life of this Agreement (in accordance with Part 11).
 - (c) productivity gains will not be achieved at the expense of health and safety standards.
 - (d) the disputes settlement procedures provided herein are strictly adhered to.
 - (e) employment should wherever possible be direct, full time and on going.

9 Severability

- 9.1 It is the intention of the Parties to this Agreement that the Agreement contains only permitted matters under the Fair Work Act.
- 9.2 The severance of any term of this Agreement that is, in whole, or in part, of no effect by virtue of the operation of section 253 of the Fair Work Act shall not be taken to affect the binding force and effect of the remainder of the Agreement.
- 9.3 All terms should be interpreted in a manner that would make them permitted matters.

10 Flexibility Arrangements

- 10.1 The Employer and an Employee may agree to make an individual flexibility arrangement to vary a term of the Agreement if the arrangement:
- (a) only varies the effect of
 - (i) **clause 46** Parental Leave
 - (ii) **clause 43** Compassionate Leave
 - (iii) **clause 45** Jury Service
 - (b) meets the genuine needs of the Employer and Employee in relation to the matter mentioned in **clause 10.1(a)** above:
 - (i) is genuinely agreed to by the Employer and Employee; and
 - (ii) is not inconsistent with section 55 of the Fair Work Act.
- 10.2 The Employer must ensure that the terms of the individual flexibility arrangement:
- (a) are about permitted matters under section 172 of the Fair Work Act;
 - (b) are not unlawful terms under section 194 of the Fair Work Act; and
 - (c) result in the Employee being better off overall than the Employee would be if no arrangement was made.
- 10.3 The Employer must ensure that the terms of the individual flexibility arrangement:
- (a) is in writing;
 - (b) includes the name of the Employer and the Employee;
 - (c) is signed by the Employer and the Employee (if the Employee is under the age of 18, signed by a parent or guardian of the Employee);
 - (d) includes details of:
 - (i) the terms of this Agreement that will be varied by the arrangement;
 - (ii) how the arrangement will vary the effect of the terms;
 - (iii) how the Employee will be better off overall in relation to the terms and conditions of his or her employment as a result of the arrangement; and
 - (iv) states the day on which the arrangement commences.

- 10.4 The Employer must give the Employee a copy of the individual flexibility arrangement within fourteen (14) days.
- 10.5 Upon request by the relevant Employee/s, the Employer must provide copies of all flexibility arrangements made under this clause to the Union/Union Delegate/Employee Representative.
- 10.6 The Employer or Employee may terminate the individual flexibility arrangement by giving not more than twenty-eight (28) days' written notice to the other Party to the arrangement; or if the Employer and Employee agree in writing at any time.

PART 2 - DISPUTE RESOLUTION AND CONSULTATION

11 Disputes Resolution Procedure

11.1 A major objective of this Agreement is to eliminate lost time and/or production arising out of disputes or grievances. The Parties to this Agreement are committed to complying with the terms of this procedure.

11.2 Scope

Disputes relating to any of the following must be dealt with according to the procedure in this clause:

- (a) any matter arising under this Agreement;
- (b) the NES, including subsections 65(5) and 76(4); and
- (c) any matter pertaining to the relationship between the Employer and the Employees.

Provided that nothing in this clause prevents a party to the dispute from applying to a court for orders in relation to contraventions of civil remedy or penalty provisions.

Note: Safety issues and incidents are to be dealt with in accordance with **clause 60** of this Agreement and with any applicable occupational health and safety legislation. A dispute about the operation, or application of **clause 60** is a matter arising under this Agreement and can be dealt with in accordance with this clause.

11.3 Procedure

Disputes will be dealt with according to the following procedure.

Step 1—workplace level

- (a) In the first instance, the parties to the dispute will take genuine steps to try and resolve the dispute at the workplace level.

Step 2—dispute resolution including arbitration by the Panel

- (b) If the dispute remains unresolved after Step 1, a party to the dispute (or its representative) may refer the dispute to the Victorian Building Industry Disputes Panel (Panel). If a party to the dispute refers the dispute to the Panel, all parties irrevocably consent to the Panel dealing with the dispute, including by arbitration.
- (c) The Panel may deal with the dispute by conciliation, arbitration, otherwise as it sees fit, or by any combination of methods, provided that it acts in accordance with its Charter, and must not make any decision or impose any other binding outcome which requires a party to the dispute to do something that is prohibited by any applicable legislation.
- (d) If the Panel deals with the dispute by arbitration and makes an arbitral award (**Decision**):

- (i) any party to the dispute (or its representative) may, within 14 days after the date of the Decision, have the Decision reviewed by the FWC, in which case Step 3 below applies;
- (ii) if no party refers the Decision for review within the period stated in **clause 11.3(d)(i)** above, that Decision will be final and binding on the parties to the dispute.

Step 3—Referral to the FWC

- (e) If a party to the dispute refers the Decision for review to the FWC, all parties to the dispute irrevocably consent to the FWC dealing with the dispute, including by arbitration.
- (f) A review by the FWC is not a hearing afresh (not a hearing de novo); it is a review by way of rehearing. This means that the FWC must identify whether the Panel has made an error of law, a material error of fact or a decision which is legally unreasonable or unjust (inferred error). It is acknowledged that the FWC has the discretion to admit new evidence as required.
- (g) The FWC may deal with the dispute by conciliation, arbitration, or by the exercise of any of its other powers under the Fair Work Act, or by any combination of methods.
- (h) If the FWC deals with the dispute by arbitration:
 - (i) by a single member of the FWC and makes an arbitral award **(FWC Decision)**:
 - (A) any party to the dispute (or its representative) may, within 21 days after the date of the FWC Decision, appeal to a Full Bench of the FWC;
 - (B) if no party appeals from the FWC Decision within the period stated in **clause 11.3(h)(i)(A)** above, that FWC Decision will be final and binding on the parties to the dispute.
 - (ii) by a Full Bench of the FWC and makes a decision, the decision will be final and binding on the parties to the dispute.

Steps available in the event of non-compliance by a party

- (i) If any party to the dispute fails or refuses to comply with or participate in Step 1 of this clause, any other non-breaching party to the dispute (or its representative) may, in its absolute discretion:
 - (i) refer the dispute to the Panel, which will deal with the dispute in accordance with Step 2 above noting that the non-breaching party may request the Panel at this stage to refer the dispute directly to the FWC to deal with the dispute by conciliation, arbitration, by the exercise of any of its powers under the Fair Work Act, or by any combination of methods.
- (j) If any party to the dispute fails or refuses to comply with or participate in Step 2 of this clause, any other non-breaching party to the dispute (or its representative) may, in its absolute discretion:
 - (i) refer the dispute to the FWC to deal with the dispute by conciliation, arbitration, or by the exercise of any of its other

powers under the Fair Work Act, or by any combination of methods; or

- (ii) continue to pursue Step 2 above, including by seeking that the Panel make a Decision despite any non-compliance or non-participation of any other party.

11.4 Directions and requests of the Panel

- (a) The Panel may inform itself in relation to any dispute in such manner as it considers appropriate in accordance with its Charter, including but not limited to by:
 - (i) requesting oral or written submissions;
 - (ii) requesting relevant documents, records or other relevant information; or
 - (iii) conducting a conference or holding a hearing.
- (b) A party to the dispute will comply with any request of the Panel made under this clause, unless the party has a reasonable excuse.

11.5 Enforcement

- (a) Finality of a Decision
 - (i) Subject only to the rights of review/appeal expressly provided for in this clause, a Decision or an FWC Decision (or any subsequent Full Bench decision) is final and binding and may be immediately enforced.
- (b) Enforcement of a Decision
 - (i) All parties to a dispute must comply with, and give effect to, any Decision or FWC Decision.
 - (ii) A party to a dispute that fails to comply with, or give effect to, a Decision or FWC Decision, contravenes this clause.
 - (iii) The Parties agree that:
 - (A) any Decision or FWC Decision may be enforced by an action seeking appropriate remedies (including, but not limited to, payment of a debt, damages, or specific performance) in any court of competent jurisdiction; and
 - (B) interest will accrue on any sum payable under a Decision or FWC Decision at the rate prescribed from time to time in respect of pre-judgment interest under the Rules of the Federal Court of Australia.

11.6 Status quo

- (a) While the dispute is being dealt with in accordance with the procedure in this clause:
 - (i) the Parties will maintain the status quo existing immediately prior to the subject matter of the dispute arising. Neither Party will engage in any industrial stoppages, bans and or limitations. Work shall continue in accordance with the status quo unless an Employee has a reasonable concern about an imminent risk to their health or safety; however

(ii) the Employer may direct an Employee to perform other available work at the same workplace, or at another workplace, on the same terms and conditions of employment, if it is reasonable to do so to protect the health, safety or welfare of Employees.

(b) For the avoidance of doubt, "**Maintain the status quo**" means that the action giving rise to the dispute will be withdrawn, and the situation immediately prior to the action giving rise to the dispute will apply until the dispute is resolved.

11.7 **Employee participation and representation**

(a) Employees are entitled to a representative of their choice, including a Union representative, for the purposes of this clause.

(b) Employees to whom a dispute directly relates and who are necessarily required to participate in the procedure provided for in this clause are entitled to do so without loss of pay.

(c) Employees who are required to attend as a witness in an arbitration are entitled to do so without loss of pay.

(d) In the event that the parties to the dispute fail to agree on the identity or number of persons who qualify under this clause, the question will be determined by the Panel or the FWC (whichever is then dealing with the dispute) as part of the dispute.

12 **Consultation**

12.1 **Major Workplace Change**

If the Employer has made a decision to introduce a major workplace change that is likely to have a Significant Effect on a number of Employees, the Employer must notify the Employee(s) who will be affected by the decision. As soon as practicable and prior to implementation, the Employer must discuss with the relevant Employees and/or their nominated representative/s (e.g. Union or other representative) the introduction of the change; and the effect the change is likely to have on the Employees. The Employer must discuss measures to avert or mitigate the adverse effect of the change on the Employees.

12.2 For the purposes of the discussion the Employer will provide the relevant Employees and/or their nominated representative/s in writing:

(a) all relevant information about the change including the nature of the change proposed;

(b) information about the expected effects of the change on the Employees; and

(c) any other matters likely to affect the Employees.

However, the Employer is not required to disclose confidential or commercially sensitive information.

The Employer must give prompt and genuine consideration to matters raised about the major change by the relevant Employees.

12.3 "Significant Effects" under this **clause 12** include termination of employment (including Redundancy), major changes in the composition, operation or size of the Employer's workforce or in the skills required, the elimination or diminution

of job opportunities, promotion opportunities or job tenure; the alteration of hours of work; the need for retraining or transfer of Employees to other work areas or locations and the restructuring of jobs.

12.4 Consultation about Changes to Rosters or Hours of Work

Where the Employer proposes to change an Employee's regular roster or ordinary hours of work, the Employer must consult with the Employee(s) affected and, if required their representative, about the proposed change.

12.5 As soon as practicable after proposing to introduce the change, the Employer must:

- (a) discuss with the relevant Employees the introduction of the change; and
- (b) for the purposes of the discussion, provide to the relevant Employees and their representative if requested by the Employees:
 - (i) all relevant information about the change, including the nature of the change; and
 - (ii) information about what the Employer reasonably believes will be the effects of the change on the Employees; and
 - (iii) information about any other matters that the Employer reasonably believes are likely to affect the Employees; and
- (c) invite the Employee(s) affected and any applicable representatives, to give their views about the impact of the proposed change (including any impact in relation to their family or caring responsibilities); and give consideration to any views about the impact of the proposed change that are given by the Employee(s) concerned and/or their Union.

12.6 The requirement to consult under this clause does not apply where an Employee has irregular, sporadic or unpredictable working hours.

12.7 These provisions are to be read in conjunction with other Agreement or Award provisions concerning the scheduling of work and notice requirements.

13 Flexibility Arrangements on Significant, Major or Unusual Projects

13.1 The Parties are committed to working together, in a manner consistent with the terms of the Agreement, to promote productivity and ensure the elimination of any matters which may otherwise give rise to an industrial dispute. Accordingly, if the Employer requires the implementation of productivity measures specific to a significant, major or unusual Project, which may include special and exceptional circumstances, the Employer will consult with the affected Employee(s) in accordance with this clause.

13.2 Without limiting the general intention of this clause, the Parties recognise a particular requirement for establishing flexible starting times, as well as to develop other working arrangements that facilitate efficient movement of the workforce whilst still protecting the rights of individual Employees.

13.3 Where the significant, major or unusual Project is in a regional area, consultation will also occur to provide opportunity for employment of local labour.

13.4 Consultation shall commence as soon as practicable, following the announcement of the significant, major or unusual Project. In order to facilitate consultation, the Employer will provide:

- (a) all relevant information about the significant, major or unusual Project including the nature of the significant, unusual and major Project proposed;
 - (b) information about the expected effects of the significant, major or unusual Project on the Employees; and
 - (c) any other matter that is relevant to the significant, major or unusual Project, including the application of **Appendix C**.
- 13.5 During consultation under this clause, other matters that may be discussed include:
- (a) scheduled shutdowns;
 - (b) safety;
 - (c) work on RDOs;
 - (d) opportunities to promote employment of apprentices; and
 - (e) diversity of employment.
- 13.6 For the purposes of this clause 'consultation' involves the Employer proposing productivity measures for the significant, major or unusual Project and the Employees giving prompt and genuine consideration to those proposed measures of the Employer.
- Note: An Employee has the right to determine their representation (if any) for the purposes of this clause in accordance with Part 7 – Employee Representation of this Agreement.
- 13.7 However, the Employer is not required to disclose confidential or commercially sensitive information about the significant, major or unusual Project.
- 13.8 Any Party may seek the assistance of the Disputes Panel to facilitate consultation under this clause at any time, including dealing with matters in accordance with **Appendix C**.

PART 3 - TYPES OF EMPLOYMENT AND TERMINATION OF EMPLOYMENT

14 Contract of Employment

14.1 Daily Hire Employment

With the exception of:

- (a) casual Employees; part-time Employees, employed pursuant to **clause 14.2**; and mechanical plant operators employed as full-time weekly hire Employees, all Employees covered by this Agreement shall be engaged as daily hire Employees.

14.2 Part Time/ Job Sharing

- (a) The Parties recognise the value of enhancing employment opportunities for workers who may require part-time work arrangements due to their personal circumstances. Such circumstances may include advanced age, infirmity, family and caring responsibilities or the desire for gradual transition to retirement. In pursuit of this objective, such Employees may be engaged on a part-time basis, subject to prior consultation and agreement between the Employer and the Union on each occasion.
- (b) The Parties recognise that predecessor enterprise agreements have generally not provided for part time employment. It is the intention of the Parties to provide for only a limited expansion of part time work opportunities under this Agreement to achieve the above objective.
- (c) A part-time Employee is an Employee who works an average of less than 36 hours per week and has reasonably predictable hours of work.
- (d) A part-time Employee will receive the same rates terms and conditions of employment as a full-time daily-hire or weekly hire Employee as the case may be, except all accruals and contributions to entitlement funds (including Incolink, superannuation etc.) will be made on a pro-rata basis based on the part time Employee's ordinary hours. To be clear, part time employment pursuant to this clause is the only circumstance under this Agreement for which pro-rata payment of these entitlement funds applies.
- (e) The Employee's LeavePlus contribution will be in accordance with the applicable scheme rules.
- (f) Before commencing part time employment, the Employer, the Employee and the Union will agree in writing to the following:
 - (i) that the Employee is engaged part time;
 - (ii) upon the ordinary hours to be worked by the Employee, the days and hours upon which the Employee will perform work and the commencing times for the work;
 - (iii) upon the Employee's classification; and
 - (iv) upon the period of part time employment.

- (g) The terms of an agreement to work part time may be varied, in writing, by agreement between the Employer, the Employee and the Union.
- (h) The Employer will provide a copy of the agreement to the Employee and the Union and any subsequent variation will be in writing.
- (i) A part-time Employee may work up to eight (8) ordinary hours each day, Monday to Friday, and not more than 36 ordinary hours each week averaged over a two-week period. Any additional hours may be worked by agreement only. Such agreement may include the application of penalty rates for any additional hours worked, even where the total ordinary hours on any given day remain less than 8.
- (j) Any hours of work performed outside the spread of ordinary hours or in excess of 8 hours in any one day must be paid at the appropriate penalty rate(s).
- (k) The RDO system prescribed by **clause 37** will apply to a part-time Employee on a pro rata basis. This means that 0.1 of an hour for each ordinary hours worked and paid leave taken will not be paid but will accrue towards an RDO. When the RDO falls, the Employee will be paid an amount based on their RDO accrual.
- (l) The Parties recognise that the preferred mode of employment under this Agreement will remain full-time direct employment and the requirements of a full-time role are in no way diminished by the provision of part time work. The Parties recognise that one effective means of maintaining productivity levels and ensuring appropriate coverage on site may be via job sharing arrangements, whereby Employees are engaged to work complementary hours of work such that the combined hours of work and like aspects of employment for two employees are practically equivalent to those of one full time employee. Examples of potential job-sharing arrangements are set out in **Appendix O**.
- (m) The parties commit to the regularly monitoring and evaluation of the effectiveness of these measures. Adjustments and improvements will be made as necessary to ensure continuous progress towards the objectives of this clause.
- (n) Nothing in this clause is intended to limit the rights of Employees under any relevant legislation.

14.3 **Casual Employment**

Engagement

- 14.4 Subject to this clause, a casual Employee is one engaged as such and who has no firm advance commitment from the Employer to continuing and indefinite work according to an agreed pattern of work.

Indicia of casual employment

- 14.5 Whether the employment relationship is characterised by an absence of a firm advance commitment to continuing and indefinite work is to be assessed:
- (a) on the basis of the real substance, practical reality and true nature of the employment relationship; and

- (b) on the basis that a firm advance commitment can be in the form of the contract of employment or, irrespective of the terms of that contract, in the form of a mutual understanding or expectation between the Employer and Employee not rising to the level of a term of that contract (or to a variation of any such term); and
- (c) having regard to, but not limited to, the following considerations (which indicate the presence, rather than an absence, of such a commitment):
 - (i) whether there is an inability of the Employer to elect to offer work or an inability of the Employee to elect to accept or reject work (and whether this occurs in practice);
 - (ii) whether, having regard to the nature of the Employer's enterprise, it is reasonably likely that there will be future availability of continuing work in that enterprise of the kind usually performed by the Employee;
 - (iii) whether there are non-casual Employees performing the same kind of work in the Employer's enterprise that is usually performed by the Employee;
 - (iv) whether there is a regular pattern of work for the Employee.
- (d) To avoid doubt:
 - (i) for the purposes of sub-clause 14.5(b) a mutual understanding or expectation may be inferred from conduct of the Employer and Employee after entering into the contract of employment or from how the contract is performed; and
 - (ii) the considerations referred to in sub-clause 14.5(c) must all be considered but do not necessarily all need to be satisfied for an employee to be considered as other than a casual Employee; and
 - (iii) a pattern of work is regular for the purposes of sub-**clause 14.5(c)(iv)** even if it is not absolutely uniform and includes some fluctuation or variation over time (including for reasonable absences such as for illness, injury or recreation).

Casual rates, terms and conditions

- 14.6 A casual Employee shall be entitled to all the applicable rates and conditions of employment prescribed in this Agreement except annual leave, paid personal/carer's leave, paid jury service, paid compassionate leave, paid parental leave and payment for public holidays not worked.
- 14.7 The casual loadings payable under this Agreement compensate the casual Employee for entitlements available only to permanent employees under the

NES, namely annual leave, paid personal/carer's leave, paid compassionate leave, payment for public holidays not worked and notice of termination.

- 14.8 On each occasion a casual Employee is required to attend work the Employee shall be entitled, at a minimum, to payment for eight hours work plus the relevant fares and travel allowance set out in **clause 26.5**.
- 14.9 A casual Employee for working ordinary hours shall be paid 125 percent of the hourly rate prescribed in this Agreement for the Employees' classification (inclusive of a 25% casual loading).
- 14.10 Subject to the provisions of this clause and/or any other explicit provisions of this Agreement that confer a superior benefit, where this Agreement makes provision for the payment of a higher hourly rate to an Employee due to the circumstances of the performance of that work (e.g. overtime, Shiftwork, public holiday work, Inclement Weather), the hourly rate for a casual Employee engaged to perform work under the same circumstances will be 25% higher than the respective rate for a daily hire Employee, in addition to any applicable loadings, penalties, allowances etc.

Example:

Base Rate of Pay	Penalty rate – e.g. Shiftwork/public holiday rate etc.	Casual rate of pay
100%	200% (Base Rate of Pay + 100%)	225% (Base Rate of Pay + 100% + casual loading)
100%	250% (Base Rate of Pay + 150%)	275% (Base Rate of Pay + 150% + casual loading)

*Casual loading = 25% of Base Rate of Pay

- 14.11 Any work performed in excess of eight hours on any day by a casual Employee will attract overtime rates.
- 14.12 A casual Employee required to work on a public holiday prescribed by the NES must be paid 275% of the ordinary time hourly rate prescribed for the Employee's classification (inclusive of a 25% casual loading)
- 14.13 Payment in relation to Industry Funds under this Agreement must be made at the full weekly rate. Pro-rata payments do not apply. For the avoidance of doubt, multiple engagements in any one week do not give rise to an entitlement to multiple Industry Fund payments.
- 14.14 A casual Employee is not subject to the accrual of RDOs under this Agreement. For clarity ordinary hours of work for a casual Employee will be worked for up to eight (8) hours per day, Monday to Friday and between the hours of 6:00 am and 6:00 pm each day. However, subject to the provisions of

this Agreement concerning the performance of work on an RDO, where a casual Employee is directed to perform such work, penalty rates apply.

- 14.15 Termination of a casual Employee's employment shall require one hour's notice.
- 14.16 A casual Employee who is engaged by the Employer to perform work on the Friday immediately prior and the Tuesday immediately following the Building Industry Picnic Day (Picnic Day) will be entitled to be absent on Picnic Day without loss of pay. Where eligible, the casual Employee will be entitled to payment for 8 ordinary hours, inclusive of casual loading. The provisions of clause 48 – Picnic Day including eligibility and applicable rates of pay will otherwise apply to such Employees.

Casual conversion

- 14.17 Where an Employee would accrue any additional right or benefit in either the Award or applicable legislation, including by virtue of their employment meeting the definition of casual employment in those instruments, such rights or benefits will be available to the Employee as a casual Employee under this Agreement. Nothing in this clause diminishes the Parties' rights and obligations with respect to offers and requests for conversion from casual employment to permanent employment as provided for in the NES.
- 14.18 A casual Employee who has been engaged by the Employer on a regular and systematic basis for a period in excess of four weeks thereafter has the right to request in writing to have their contract of employment converted to permanent employment if the employment is to continue beyond the conversion process.
- 14.19 The decision as to whether the employment is made permanent is a decision of the Employer.
- 14.20 Where the Employer does not make a decision and inform the Employee in writing of the decision within seven days of receipt of such a request, the Employer will be deemed to have accepted the request and the Employee will automatically be converted to permanent employment thereafter.
- 14.21 A casual Employee, who has requested in writing to be converted to permanent employment pursuant to **clause 14.18** but whose request is refused by the Employer, is thereafter entitled to be paid a casual loading of 75% for all work performed.

Example:

Rate casual Employee would have received pre-refusal based on circumstances of work:	Rate casual Employee to receive post-refusal for the same work:
125%	175%
225%	275%
275%	325%

14.22 **Flexible Working Arrangement**

- (a) The Parties recognise the importance of flexible working arrangements and the right of Employees to make requests under section 65 of the Fair Work Act for flexible working arrangements. An Employee may request

a flexible working arrangement if any of the following circumstances apply to the Employee:

- (i) the Employee is pregnant;
- (ii) the Employee is the parent, or has responsibility for the care, of a child who is of school age or younger;
- (iii) the Employee is a carer (within the meaning of the *Carer Recognition Act 2010*);
- (iv) the Employee has a disability;
- (v) the Employee is 55 or older;
- (vi) the Employee is experiencing violence from a member of the Employee's family;
- (vii) the Employee provides care or support to a member of the Employee's immediate family, or a member of the Employee's household, who requires care or support because the member is experiencing violence from the member's family.

Note. An Employee may use the form provided in **Appendix K** of this Agreement.

Example. An Employee as described in subclause (a), for example, may request not to work overtime.

15 Security of Employment

- 15.1 The Employer is committed to maintaining a stable and skilled workforce, recognising its contribution to the operation of the Employer. Subject to the terms of this Agreement, daily hire (and weekly hire for mechanical plant operators) employment is the preferred type of employment under this Agreement.
- 15.2 The Employer will take all measures to achieve employment security for the daily hire Employees (and weekly hire for mechanical plant Employees) of the Employer.
- 15.3 The Employer agrees that it is highly important that work is performed effectively, efficiently and without undue pressure or bullying, and in a way that promotes Occupational Health & Safety and Equal Opportunity principles and practices in the workplace and appropriate representation of Employees should they so request. The Employer will ensure that its employment practices are consistent with the above principles and practices.
- 15.4 **Supplementary labour**
- (a) If the Employer wishes to engage supplementary labour to perform work performed by its Employees under this Agreement, the Employer must first consult in good faith with the affected Employees.
 - (b) Following consultation and subject to this clause, the decision whether to engage supplementary labour is a decision of the Employer alone. Any dispute as to the application of this clause will be dealt with under the disputes settlement procedure under **clause 11** of this Agreement. The Employer will ensure that all supplementary labour is engaged on lawful terms and conditions.

- (c) The Parties agree that crane crew will be employed on a direct full-time basis by either the Principal Contractor, Structure Subcontractor / Formworker or crane owner.
- (d) It is acknowledged that crane crew labour hire is for the purpose of supplementary labour and is temporary in nature. Where there is a requirement for a supplementary crane crew the Parties will consult and agree on alternative short-term arrangements. Examples of where a short-term alternative may be required include:
 - (i) where a task requires the permanent crane crew to be switched to a night shift and a day shift crew is required temporarily
 - (ii) where a crane crew has not yet completed a Project and a new Project has commenced
 - (iii) where a member of the crane crew is on leave

15.5 **Sham Contracting and Anti-Wage Theft**

The Parties acknowledge the importance of complying with all applicable laws prohibiting sham contracting and wage theft including, but not limited to, the:

- (a) Fair Work Act;
- (b) *Wage Theft Act 2020* (Vic)
- (c) *Modern Slavery Act 2018* (Cth); and
- (d) *Independent Contractors Act 2006* (Cth).

15.6 **Sham Contracting**

- (a) The Parties to this Agreement acknowledge that sham contracting has the potential to undermine fair employment practices, erode Employee entitlements and affect the job security of Employees covered by this Agreement. A sham contracting arrangement includes where an employer attempts to disguise an employment relationship as an independent contracting arrangement. This is usually done for the purposes of avoiding responsibility for employee entitlements.
- (b) In this clause, "sham contracting" is where:
 - (i) an employer employs, or proposes to employ, an individual, representing to the individual that the contract of employment under which the individual is, or would be, employed by the employer is a contract for services under which the individual performs, or would perform, work as an independent contractor;
 - (ii) an employer dismisses, or threatens to dismiss, an individual who is an employee of the employer and performs particular work for the employer in order to engage the individual as an independent contractor to perform the same, or substantially the same, work under a contract for services; or
 - (iii) an employer employs, or has at any time employed, an individual to perform particular work makes a statement that the employer knows is false in order to persuade or influence the individual to enter into a contract for services under which the individual will perform, as an independent contractor, the same, or substantially the same, work for the employer.

- (c) **Clause 15.6(b)(i)** does not apply if the employer proves that, when the representation was made, the employer did not know and was not reckless as to whether the contract was a contract of employment rather than a contract for services.
- (d) Any use of sham contracting is a breach of this Agreement.
- (e) Where a sham contracting arrangement has been reasonably alleged and is unable to be resolved at the workplace level, any Party may refer the allegation directly to the Disputes Panel for conciliation and/or resolution under **clause 11** of this Agreement. All Parties will cooperate with the requests of the Disputes Panel including requests to provide substantiating information or undertaking an independent audit of their arrangements. For the avoidance of doubt, an affected Employee may appoint a representative in relation to such matters.
- (f) Where the sham contracting allegation exists on the Employer's Project, the Employer will make itself available to assist the disputes resolution procedure.
- (g) Where the Disputes Panel Chair deems it necessary due to seriousness of the allegations and/or their findings, the Chair may refer the matter to the appropriate government authority.
- (h) Where it is agreed or determined by the Disputes Panel or FWC that a sham contract was in place and the person was in fact an Employee under this Agreement, the calculation for back pay will be calculated on the basis of the hourly rate contained in this Agreement plus the site allowance (if applicable), plus the multi-storey allowance and an additional 75% loading to cover entitlements other than CBUS and Incolink. Any difference between the hourly rate paid to the Employee, plus CBUS and Incolink will form the settlement for breach of this clause. The affected Employee will be re-inducted and fully informed of their entitlements under this Agreement and the Fair Work Act.
- (i) The Employer must ensure that a person engaged to undertake building work as an Employee or as an independent contractor is lawfully entitled to be so engaged under Australian law.
- (j) The Employer agrees that the Employees will be paid in accordance with the applicable wage rates and allowances as prescribed in this Agreement.
- (k) The Employer in particular acknowledges the Sham Contracting Compliance Checklist, as attached at **Appendix L**, provides a useful tool to ensure ongoing compliance.

15.7 **Anti-wage theft**

- (a) The Employer is committed to ensuring that all Employees are remunerated properly in accordance with this Agreement. Any failure to do so constitutes a breach of this Agreement. The Employer must not deliberately withhold wages, superannuation or Employee entitlements, falsify Employee records, or fail to keep employment records.
- (b) Any falsification of pay slips or Employee records is a breach of this Agreement.

16 Use of Subcontractors

- 16.1 Where the Employer seeks to subcontract structure works that may be performed by Employees covered by this Agreement, only genuine subcontractor businesses should be utilised. Works may be sub-subcontracted to genuine subcontractor businesses: where direct engagement is not practicable; or where it is consistent with custom and practice (for example, when contractors subcontract packages of work that they do not self-perform to key trades such as steel fixers, concretors and post tensioning etc.). The intent remains that key trades including formworkers and stripping crews will be employed directly by the Employer.
- 16.2 Where the Employer engages a Subcontractor to perform work that may be performed by Employees covered by this Agreement, it will review documentation regarding the Subcontractor's compliance with applicable workplace laws (which may include compliance with the relevant industrial instrument, workers' compensation insurance, superannuation, portable long service leave (LeavePlus) and applicable industry Redundancy funds (for example, Incolink)).
- 16.3 The Employer will, on request from its Employee or the Union, who has a reasonable belief of a non-compliance with **clause 16.2** above, provide evidence demonstrating its compliance.
- 16.4 Nothing in this clause requires information to be provided in a manner that is inconsistent with the *Privacy Act 1988* (Cth).

17 Visa Compliance

- 17.1 The Employer will ensure all Employees are lawfully entitled to work in Australia performing work under the Agreement. In circumstances where the proposed employment of overseas workers on any temporary visa forms part of a "major workplace change", the Employer acknowledges its obligations to consult in accordance with **clause 12** – Consultation of this Agreement.
- 17.2 Should the Parties find themselves in disputation under this clause as to whether an Employee is entitled to work in Australia and/or is paid the appropriate rates, and the dispute is not able to be resolved at the workplace level, the matter shall be referred to the Disputes Panel under **clause 11** of the Agreement.
- 17.3 The Employer will maintain HR systems (including utilising the VEVO system on an ongoing basis), to ensure that temporary foreign Employees are at all times employed in accordance with the conditions of their visas.
- 17.4 Existing and prospective Employees will be required to complete an Authority obtained from the DHA with details of immigration status. No person will be allowed to undertake any work for the Employer unless it is verified that he/she has the right to work in Australia.
- 17.5 The Employer must ensure that no person who is not an Australian citizen or Australian permanent resident (within the meaning of the *Migration Act 1958*), or does not otherwise have unrestricted work rights, is employed to undertake building work for the Employer unless:
- (a) the position is first advertised in Australia; and

- (b) the advertising was targeted in such a way that a significant proportion of suitably qualified Australian citizens and Australian permanent residents would be likely to be informed about the position; and
- (c) any skills or experience requirements set out in the advertising were appropriate to the position; and
- (d) the Employer demonstrates that no Australian citizen, Australian permanent resident or person with unrestricted work rights is suitable for the job.

18 Notice of Termination

18.1 Daily Hire - Tradespersons & Labourers

One days' notice of termination shall be given by either side, or one day's pay shall be paid or forfeited.

18.2 Weekly Hire - Mechanical Plant Operators and Part Time Employees

If the Employer decides to terminate the employment of a Weekly Hire Employee, the Employer shall give the following notice:

Period of Continuous Service	Period of Notice
One (1) year or less	One (1) week
Over one (1) year & up to the completion of three (3) years	Two (2) weeks
Over three (3) years & up to the completion of five (5) years	Three (3) weeks
Over five (5) years	Four (4) weeks

In addition to the above notice, Employees over 45 years of age with not less than two (2) years continuous service shall be entitled to an additional one (1) week's notice.

Notice of resignation by Weekly Hire Employee - The notice given by a Weekly Hire Employee shall be the same as that required of the Employer except that there shall be no additional notice based on the age of the Weekly Hire Employee concerned.

18.3 Termination without Notice

The Employer may terminate an Employee's employment without notice if the Employee engages in serious misconduct.

18.4 Termination prior to a Public Holiday

- (a) If the Employer terminates the employment of an Employee, the Employer will pay the Employee a day's ordinary wages for each public holiday prescribed in this Agreement which falls within ten (10) consecutive calendar days after the date the Employee's employment is terminated. For clarity, day one is the day after the Employee's employment was terminated.
- (b) Where two (2) or more of the holidays fall within a seven (7) day span, such holidays shall be a 'group' of holidays. If the first day of the group of holidays falls within ten (10) consecutive calendar days after the date the Employee's employment is terminated, the whole group shall be deemed to fall within the ten (10) consecutive days, and the Employee will be

paid a day's ordinary wages for each such day. For example, Christmas Day, Boxing Day and New Year's Day (or days in lieu thereof) shall be regarded as a group.

19 Additional Provisions

- 19.1 Upon termination of employment, the Employer shall pay each terminated Employee all accrued entitlements and other wages owing and provide a separation certificate within two (2) business days of termination, unless otherwise agreed in writing between the Employer and Employee, or the Employee shall be entitled to claim payment for all time beyond the two working days, up to a maximum of 8 hours per day, including Saturday and Sunday, until the entitlements are paid.
- 19.2 Within 2 days of termination the Employer will supply the relevant paperwork to allow an Employee to access their Incolink Redundancy Fund. Within one week of termination, the Employer will comply with reporting of remaining sick days to Incolink for the purpose of Portable Sick Leave.

20 Redundancy

- 20.1 Subject to the following procedure, it is agreed that it is the Employer's prerogative to determine the order of selection of Employees for employment or retrenchment.
- 20.2 All relevant legislation governing unfair dismissal, discrimination etc. will be observed.
- 20.3 Voluntary terminations will be encouraged as a first step.
- 20.4 The seniority of Employees - within classifications, experience or skills held - will be observed by the Employer in selecting Employees for retrenchment.
- 20.5 The dispute settlement procedures set out in Part 2 will apply in the event of any concerns arising regarding retrenchments.
- 20.6 An Employee is entitled to access their Redundancy payments when they cease to be employed by the Employer. The amount of the Redundancy payment shall be whichever is the greater of the entitlement due under the Award as in force from time to time or the entitlement of the Employee under the Nominated Redundancy Fund trust deed (or under the constituting documents of any fund nominated by Incolink under this clause).

Note that the industry-specific Redundancy scheme prescribed by the Award as in force from time to time is expressly incorporated into this Agreement (including for clarity, in respect of work falling within the scope of **clause 4.2**).

21 Industry fund compliance

- 21.1 The Employer shall ensure that all its Employees covered by this Agreement are compliant with the industry schemes Incolink, Superannuation (including CBUS where the default fund is adopted) and LeavePlus.
- 21.2 It is acknowledged that information confirming compliance (i.e. registration and contribution status) may be provided by the industry scheme/s to the Parties on request, provided that any individual whose information is to be made available has consented to such information being provided.
- 21.3 On commencement, and in accordance with fund procedures, the Employer shall register the Employee/s with the relevant industry funds. These are CBUS

for superannuation, Incolink for severance pay, portable sick leave, bill payer insurance and income protection insurance, and LeavePlus for long service entitlements.

- 21.4 It is a specific requirement that the Employer shall ensure that all payments to the abovementioned funds and schemes are up to date and made in full in accordance with the relevant Trust Deed or scheme of the fund.
- 21.5 When an Employee or their representative raises a concern in respect of the Employee's entitlements and/or the Employer's compliance with payments and/or registration with the abovementioned funds or schemes, the Employer shall provide to the Employee, or their representative if requested by the Employee, all relevant information to assist in resolving any concerns.
- 21.6 **Failure to Make Payments to Industry Funds etc.**
If a person covered by this Agreement has a genuine and reasonable belief that the Employer has failed to comply with **clauses 21 to 24** (inclusive) the following process will apply:
- (a) the person or their representative must notify the Employer in writing of the alleged noncompliance and what must be done to remedy it;
 - (b) the Parties must consult in good faith in an effort to resolve the matter;
- 21.7 Any disputes related to this clause shall be dealt with via the disputes procedure. The Parties are committed to resolving any genuine and reasonable disagreement about whether any amount is owing or outstanding as quickly as practicable.
- 21.8 **Additional Remedy for Non-Compliance with Superannuation**
If the Employer does not contribute the amounts in accordance with this Agreement, the relevant Trust Deed and the Fund or scheme the Employer shall be liable to make the appropriate contributions immediately upon notification of the non compliance. Further, the Employer shall pay the earnings on the relevant Trust Deed and the Fund or scheme that would have accrued during the period of non-payment. The requirement for the Employer to make retrospective payments shall not limit any common law action which may be available in relation to death, disablement or any other cover existing within the terms of a relevant fund.
- 22 Superannuation**
- 22.1 Superannuation contributions must be paid in accordance with this clause and the *Superannuation Guarantee Administration Act 1992* (Cth), which will satisfy the Employer's obligation regarding making superannuation contributions under the NES.
- 22.2 Subject to applicable legislation regarding choice of fund and/or stapled funds, the Employer will make superannuation payments on behalf of each Employee into CBUS as the default fund.
- 22.3 The level of contributions paid on behalf of each Employee (other than an Apprentice) will be, at a minimum, \$280 per week.
- 22.4 Pro-rata payment does not apply, except in the case of flexible working arrangements entered into pursuant to **clause 14.2**.

22.5 The level of contributions paid on behalf of each Apprentice must be, at a minimum:

	1st Year - 55%	2nd Year – 70%	3rd Year – 85%	4th Year – 100%
Minimum contribution	\$154.00	\$196.00	\$238.00	\$280.00

22.6 The above contributions may be counted by the Employer as an offset against any payments otherwise required to be made by the Employer to avoid the Employer being required to pay the superannuation guarantee charge under superannuation legislation with respect to an Employee. However, the above contribution rates do not limit the Employer's liability under the *Superannuation Guarantee (Administration) Act 1992* (Cth).

22.7 All superannuation contributions will be paid at least monthly subject to the relevant governing trust deed, rules and/or legislation.

22.8 Salary sacrifice

- (a) Where an Employee wishes to have their pay salary sacrificed for additional superannuation, the Employer will comply with the Employee's request without unreasonable delay and consistent with any relevant statutory requirements.
- (b) All entitlements and benefits contained in this Agreement will be calculated on the pre-salary sacrifice pay rate.

22.9 Where an Employee nominates an eligible superannuation fund other than CBUS, references to CBUS in this Agreement will be read as the eligible superannuation fund nominated by the Employee.

23 LeavePlus (Long service leave)

23.1 Long Service Leave Scheme

- (a) All Employees will be registered by the Employer with LeavePlus. When an Employee has accrued an entitlement to long service leave, and after giving four (4) weeks' notice to the Employer, the Employee will be entitled to take such leave, subject to agreement with the Employer. Agreement for leave will not be unreasonably withheld by the Employer.
- (b) Long service leave shall be in accordance with and provided by ColInvest Limited (trading as LeavePlus).
- (c) The Employer shall pay all charges required by the *Construction Industry Long Service Leave Act 1997* (Vic).

24 Incolink

Redundancy Contributions

24.1 The Employer is, and will remain during the life of this Agreement, a member of the Redundancy Payment Approved Worker Entitlement Fund 1 ("Incolink Number 4 Fund") of which Redundancy Payment Central Fund Ltd ("Incolink") is trustee or an equivalent approved worker entitlement fund that is administered and/or managed by Incolink (the "**Nominated Redundancy Fund**"). References in this clause to "Nominated Redundancy Fund" include a reference to another fund for comparable purposes nominated by Incolink for

the purposes of this Agreement as a fund which supersedes the Incolink Number 4 Fund.

- 24.2 All Employees of the Employer will be enrolled by the Employer in the Nominated Redundancy Fund and be entitled to Redundancy benefits in accordance with the terms of the relevant Trust Deed.
- 24.3 The Employer will pay a minimum of \$160 to the Nominated Redundancy Fund on behalf of each Employee on a weekly basis (except where **Clause 24.4** applies) in accordance with the trust deed or other governing documents, save that if Incolink nominates any other fund under **clause 24.1** the Employer will pay contributions to that fund on behalf of each Employee on a weekly basis and in accordance with the governing documents of that other fund.
- 24.4 Redundancy contributions on behalf of Employees who have entered in to a part-time/job sharing arrangement under **clause 14.2** will be pro-rated. For clarity casual Employees are entitled to the full contribution at **clause 24.3** above.
- 24.5 The liability of the Employer to pay redundancy payments to an Employee under this clause will be met by the making of the contributions on behalf of the Employee required as a member of the Nominated Redundancy Fund, or by another fund nominated by Incolink under **clause 24.1**.

Income Protection, Trauma and Journey Insurance

- 24.6 The Employer is, and will remain during the life of this Agreement, a participating employer in the Nominated Redundancy Fund and an employer member of IPT Agency Co Ltd. IPT Agency Co Ltd administers the insurance schemes covering income protection, trauma and journey accidents (**Income Protection, Trauma and Journey Accidents Insurance Schemes**).
- 24.7 The Employer will pay contributions to IPT Agency Co Ltd on behalf of each Employee, on a monthly basis, in accordance with the Constitution and By-laws of IPT Agency Co Ltd.
- 24.8 Pursuant to the Income Protection, Trauma and Journey Accidents Insurance Schemes, Employees will:
- (a) **(Income Protection)** receive defined weekly payments available from Incolink as outlined the table below in the event of an extended work absence arising from any personal illness or injury that occurs at the time the employee is an Employee of the Employer.

Date	Benefit (per week)	Employer Weekly Payment
1 October 2023	\$1,550	\$31.50
1 October 2024	\$1,600	\$32.00
1 October 2025	\$1,700	\$35.50
1 October 2026	\$1,800	\$38.50
1 October 2027	\$1,900	\$42.00

- (b) **(Trauma)** receive or have paid on their behalf financial compensation in the event of a major work-related accident (i.e. WorkCover) resulting in the death or permanent disablement of the Employee and occurring at

the time the employee is an Employee of the Employer (the full and precise conditions of this cover will be in accordance with the terms of the insurance policy and is available from Incolink).

- (c) **(Journey Accidents)** receive payments in accordance with the terms of the insurance policy for the duration of the Employee's absence (the full and precise conditions of this cover will be in accordance with the terms of the insurance policy and is available from Incolink) if:
 - (i) the absence is because the Employee is unable to work due to injuries resulting from any accident incurred during travel between the Employee's residence and the workplace, that occurs at the time the Employee is an employee of the Employer; and
 - (ii) all such absences are supported by certification of a duly authorised medical practitioner and indicating the causal nexus between the travel to and from work and the Employee's inability to attend for work.
- (d) **(Child Care Assistance Benefit)** receive payments in accordance with the terms of the insurance policy.
 - (i) in the event of the death of an Employee or their dependent spouse, the surviving spouse will receive a benefit through Incolink to reimburse reasonable childcare expenses incurred at a registered child care facility within the 12 months following the death of the Employee or dependent spouse.
 - (ii) the maximum amount payable under this benefit is \$30,000 or as increased in accordance with the policy.
- (e) **(Pre-Term Labour and Miscarriage Benefit)** receive payments in accordance with the terms of the insurance policy. In summary these are:
 - (i) if, during the operative time of the policy the Employee suffer premature childbirth (prior to 26 weeks gestation), or stillbirth (a fetal death prior to birth of a baby of 20 or more completed weeks of gestation or of 400 grams or more birthweight) a lump sum benefit of \$10,000.

24.9 Portability of Sick Leave

- (a) The Employer is, and will remain during the life of this Agreement, a participating employer in the Construction Industry Complying Portable Sick Leave Pay Scheme ("**Incolink PSL Scheme**") of which Incolink is trustee, and all the Employees will be enrolled in the Incolink PSL Scheme and be entitled to sick leave benefits and up to five (5) days' carer's leave, in accordance with the terms of the trust deed or other governing documents and the related insurance policy.
- (b) The Employer will pay contributions to the Incolink PSL Scheme on behalf of each Employee on a weekly basis in accordance with the trust deed or other governing documents.
- (c) The contribution will be \$3.00 per week.
- (d) If Incolink nominates any other fund under **clause 24.1** hereof, the Employer will pay contributions to that fund on behalf of each Employee

on a weekly basis and in accordance with the governing documents of that other fund.

- (e) References in this clause to "Incolink PSL Scheme" include a reference to another fund for comparable purposes nominated by Incolink.

24.10 Bill Payer Insurance

- (a) If an Employee is in receipt of an Incolink benefit and suffers a disability for a period of more than 14 days, they will have access to a benefit under a policy procured by Incolink to reimburse domestic bills which the worker receives and pays during their disablement.
- (b) This policy will reimburse up to \$300 per bill up to a maximum of \$6,000 for all bills for any one period of disablement.
- (c) The Employer will pay a contribution on behalf of each Employee of \$1.50 per week per Employee in accordance with the relevant Incolink trust deed or other governing documents.

24.11 Funeral Cover

- (a) The Employer will pay contributions to Incolink for Funeral Cover on behalf of each Employee on a weekly basis in accordance with the trust deed or other governing documents.
- (b) The contribution will be \$1.50 per week.
- (c) Employees may access this cover in accordance with the relevant Incolink Funeral Cover Scheme.

24.12 Funding for Training

- (a) In furtherance of the objectives of **clause 32 and Appendix P** hereof, and as a further initiative to enhance the employment and career opportunities of the Employees, the Parties to this Agreement will continue to facilitate on-going training to improve OHS in the industry and to improve Employees' work skills so as to advance progression to higher industry skill levels.
- (b) To support the cost of these training initiatives the Employer will make a payment per Employee per week as per the table below. Such monies will be paid into Incolink to support Incolink's continued training funding initiatives.

1 July 2024	\$12.50
1 October 2025	\$13.50
1 October 2026	\$16.00
1 October 2027	\$18.50

Provided that the Incolink arrangements are appropriately ordered so as to provide for:

- (i) joint employer/Union management of the training funding;
 - (ii) access to funding in accordance with agreed guidelines, by all participating employers and unions.
- (c) In the event of Incolink being unable to provide the above arrangements, the Parties to this Agreement agree to establish an alternative

mechanism with the intention of meeting the commitments expressed in **clause 24.11(b)** above.

- (d) The liability of the Employer to pay for the cost of training courses they approve in accordance with **clause 32 and Appendix P**, will be met by the making of the contributions on behalf of each Employee as required by this clause.
- 24.13 The Employer will make a weekly contribution to the Nominated Redundancy Fund for the purpose of the Nominated Redundancy Fund funding and/or sponsoring activities (at the determination of the Trustee of the said fund) that support the welfare of all Employees and their families in the building and construction industry.
- 24.14 This contribution is calculated based on the number of Employees employed by the Employer at the rate of \$0.95 per Employee, per week.

PART 4 - CLASSIFICATIONS AND MINIMUM WAGE RATES

25 Wage Rates

- 25.1 All Employees working under this Agreement shall be classified according to Schedule B of the Award using the classification structure set out in **Appendix A** of this Agreement as a guide.
- 25.2 Wages will be increased in accordance with **Appendix B** from each Pay Period listed below:
- (a) From 1st Pay Period commencing on or after 1 July 2024;
 - (b) from 1st Pay Period commencing on or after 1 February 2025;
 - (c) from 1st Pay Period commencing on or after 1 February 2026; and
 - (d) from 1st Pay Period commencing on or after 1 February 2027.
- 25.3 It is agreed that the wage increase on 1 February 2027 will be the only wage increase for the 12 months commencing 1 February 2027.
- 25.4 These rates of pay are inclusive of the following Award prescribed entitlements:
- (a) Base Rates of Pay
 - (b) Follow the Job Loading
 - (c) Industry Allowance
 - (d) Tool Allowance but only in respect of **clause 21.1(a), clauses 21.1(b) to (d)** and other **Award provisions** relating to the supply of tools continue to apply
- 25.5 Any variation or increase in Award entitlements shall not flow on to the adult rates prescribed herein.

26 Allowances

- 26.1 **Site allowances** shall be paid in accordance with the allowances set out in **Appendix C**, or as determined by the Disputes Panel pursuant to the provisions of **Appendix C**.
- 26.2 Subject to **clause 26.1** and **Appendix C**, Employees are entitled to the allowances set out at **Appendix M**.
- 26.3 **Multi-Storey Allowance**
- (a) In addition to the wage rates and site allowances provided in this Agreement, Multi-Storey Allowance will be applicable in accordance with **clause 23.3 of the Award**. The applicable rate for Multi-Storey Allowance shall be as follows:
 - (b) As at 1 March 2024:

From the commencement of building to 15 th floor level	\$0.70 per hour
From the 16 th floor level to 30 th floor level	\$0.82 per hour
From the 31 st floor level to 45 th floor level	\$1.27 per hour
From the 46 th floor level to 60 th floor level	\$1.65 per hour
From the 61 st floor level onward	\$2.00 per hour

- (c) Multi-Storey Allowance will be adjusted annually in accordance with CPI (All Groups, Melbourne) movements measured in the twelve-month period ending the previous December quarter effective as of 1 March from 2025 onwards, rounded to the nearest cent.

26.4 Fares and travel patterns allowance

Employees will start and cease work on the job at the usual commencing and finishing times within which ordinary hours may be worked and will transfer from site to site as directed by the Employer. Other than in the case of an Employee directed by the Employer to pick up and/or return other Employees to their homes, time spent by an Employee travelling from the Employee's home to the job and return outside ordinary hours will not be regarded as time worked. The fares and travel patterns allowance recognises travel patterns and costs peculiar to the industry, which include mobility in employment and the nature of employment on construction work.

26.5 Metropolitan radial areas

An Employee must be paid an allowance of **\$54.50 per day** for each day worked when employed on construction work, at a construction site located:

- (a) within a radius of 50 kilometres of the GPO in a capital city of a State or Territory; or
- (b) within a radius of 50 kilometres of the principal post office in a regional city or town in a State or Territory.

26.6 Distant work

Employees who are in receipt of Living Away from Home Allowance will be eligible for the allowances provided for in this clause, subject to **Appendix H– Living Away from Home Allowance**.

26.7 Country radial areas

- (a) Where the Employer has a business or branch or section thereof (for the purpose of engagement) that is established in any place (other than on a construction site) outside the areas mentioned in **clause 26.5**, Employees must be paid the allowances prescribed in clause 26.5 for work located within a radius of 50 kilometres from the post office nearest the Employer's establishment.
- (b) Where the Employer has an establishment in more than one such place the establishment nearest the Employee's nominated address will be used for purposes of this clause and Employees are entitled to the provisions of **clause 26.5** when travelling to a job outside such radial area.

26.8 Travelling outside radial areas

Where the Employer requires an Employee to travel daily from inside one radial area mentioned in **clauses 26.5, 26.6 and 26.7** to work on a construction site outside that area, the Employee will be entitled to:

- (a) the allowance prescribed in **clause 26.5** for each day worked; and
- (b) in respect of travel from the designated boundary to the job and return to that boundary:
 - (i) the time outside ordinary working hours reasonably spent in such travel, which will be paid at the ordinary time hourly rate, and calculated to the next quarter of an hour with a minimum payment of one half an hour per day for each return journey; and
 - (ii) any expenses necessarily and reasonably incurred in such travel, which will be \$0.57 per kilometre where the Employee uses their own vehicle.

26.9 Residing outside radial areas

An Employee whose residence is outside the radial areas prescribed in **clauses 26.5, 26.6 and 26.7** and who crosses a radial boundary to travel to a construction site, will be entitled to the allowance prescribed in **clause 26.5** for each day worked but not payment for the time reasonably spent in travelling from the designated radial boundary to the job and return to the radial boundary.

26.10 Travelling between radial areas

The provisions of **clause 26.5** will apply to an Employee who is required by the Employer to travel daily from one of those areas mentioned in **clauses 26.5, 26.6 and 26.7** to an area, or to another area, mentioned in **clauses 26.5, 26.6 and 26.7**.

26.11 Provision of transport

- (a) No allowances, other than those prescribed in **clauses 26.8 and 26.10** and in the circumstances described in **clause 26.11(b)**, will be payable on any day on which the Employer provides or offers to provide transport free of charge from the Employee's home to the place of work and return.
- (b) Subject to **clause 26.11(c)**, the allowance prescribed in **clause 26.5** will be payable on any day for which the Employer provides a vehicle free of charge to the Employee for a purpose related to their contract of employment, and the Employee is required by the Employer to drive this vehicle from the Employee's home to their place of work and return.
- (c) The parties recognise that in some circumstances where the Employer provides a vehicle free of charge to an Employee it will not be appropriate for the Employee to also receive the allowance prescribed in **clause 26.5**. As such, where the Employer provides a fully fuelled and maintained vehicle to the Employee such that the Employee has reasonable private use of the vehicle, the allowance will not be payable. Any disputes as to the application of this clause may be resolved via the Dispute Resolution Procedure.

Example: Where an Employee is provided with a vehicle by the Employer which is mainly used for employment related purposes, including transport of the vehicle and or tools and materials to and from work, the allowance will be payable. Where the Employee is provided with a vehicle that can reasonably be used for private purposes outside of work hours, the allowance will not be payable.

26.12 Transfer during working hours

- (a) An Employee transferred from one site to another during working hours will be paid for the time occupied in travelling and, unless transported by the Employer, must be paid reasonable cost of fares by the most convenient public transport between such sites.
- (b) Provided that where an Employee agrees to the Employer's request to use the Employee's own car for such a transfer, the Employee must be paid an allowance at the rate of \$0.95 per kilometre.

26.13 Daily entitlement

- (a) The travelling allowances prescribed in this clause will be payable for:
 - (i) any day upon which the Employee performs or reports for duty, or allocation of work; and
 - (ii) any rostered day off taken as prescribed in **clauses 35—Hours of Work, and 36—Shiftwork**.
- (b) The allowances prescribed in this subclause will be taken into account when calculating the annual leave loading.
- (c) The allowances prescribed by this subclause will not be taken into account for calculating overtime, penalty rates, annual or personal/carer's leave entitlements.

26.14 Work in fabricating yard

When an employee is required to perform prefabricated work in an open yard and is then required to erect or fix on-site, the provisions of this clause will apply.

26.15 Adjustment of allowances

For the life of this Agreement, the fares and travel allowance in **clause 26.5** of the Agreement will be adjusted annually in accordance with CPI (All Groups, Melbourne) movements measured in the twelve month period ending the previous December quarter effective as of the 1 March from 2025 onwards, rounded to the nearest 5 cents. The allowances in **clauses 26.8(b)(ii)** and **26.12(b)** will be adjusted annually in accordance with CPI (All Groups, Melbourne) measured in the twelve month period ending the previous December quarter effective as of 1 March 2025 onwards, rounded to the nearest cent.

26.16 Citylink tolls etc.

The cost of Citylink tolls or similar will be reimbursed for those Employees who are required by the Employer to use their own vehicle during working hours, but not for travel to and from work.

26.17 Expense-Related & Other Award Prescribed Allowances

All expense-related and other incorporated Award allowances not specifically addressed by this Agreement will be paid at the applicable rate provided by the Award.

26.18 **Geographic Area and Sector Specific Allowances, Conditions and Exceptions.**

The following allowances and conditions shall apply where relevant. Where the Employer does work which falls under the following headings, the Employer agrees to pay and observe the relevant respective conditions and/or exceptions set out below in each case.

Amounts payable in lieu of site allowance:

- (a) **Fast Food Allowance:** As of 1 March 2024 the Employer shall pay an allowance of \$3.20 per hour on all fast food construction, and on refurbishments with a building permit value in excess of \$470,000.

These allowances will be adjusted annually in accordance with CPI (All Groups, Melbourne) movements measured in the twelve month period ending the previous December quarter effective as of 1 March 2025, rounded to the nearest 5 cents.

On any Project where the applicable site allowance in **Appendix C** is higher, then that site allowance will apply.

- (b) **Alpine Areas:** As of 1 March 2024, the Employer shall pay an Alpine disability allowance of \$4.45 for hours worked on Projects in alpine areas.

These allowances will be adjusted annually in accordance with CPI (All Groups, Melbourne) movements measured in the twelve month period ending the previous December quarter effective as of 1 March 2025, rounded to the nearest 5 cents.

- (c) **Major Events including Phillip Island Motorcycle Grand Prix, Avalon Air Show, Albert Park Formula One Grand Prix, etc**

With the exception of the Albert Park Formula One Grand Prix, the Employer shall pay an allowance for hours worked on the above Projects.

As of 1 March 2024 the Employer shall pay an allowance of \$4.05 per hour.

These allowances will be adjusted annually in accordance with CPI (All Groups, Melbourne) movements measured in the twelve month period ending the previous December quarter effective as of 1 March 2025, rounded to the nearest 5 cents.

The Employer shall pay the current City of Melbourne (New Projects) site allowance provided for under **Appendix C** of this Agreement per hour worked on the Albert Park Formula One Grand Prix Project.

- (d) **Demolition work**

- (i) As of 1 March 2024 where Employees are directly performing demolition works that would require a demolition permit that allows the performance of such work, they will receive the amount of \$9.70 per hour or the site allowance, whichever is the greater.

This allowance will be adjusted annually in accordance with CPI (All Groups, Melbourne) movements measured in the twelve month period ending the previous December quarter effective as of 1 March 2025, rounded to the nearest 5 cents.

- (ii) As of 1 March 2024 where Employees are employed in connection with, and on work, with employees of demolition contractors (ie. working within the demolition zone and/or subject to the additional disabilities arising from that demolition), they will receive the amount of \$8.70 per hour or the site allowance, whichever is the greater.

This allowance will be adjusted annually in accordance with CPI (All Groups, Melbourne) movements measured in the twelve month period ending the previous December quarter effective as of 1 March 2025, rounded to the nearest 5 cents.

Amounts payable in addition to site allowance:

(e) **Altona Area Allowance**

As of 1 March 2024 an Employee within a 8 km radius from the intersection of Kororoit Creek Road and Millers Road, Altona shall, when employed on chemical or petrochemical plants or on commercial or industrial construction jobs within 1 km of the nearest part of the perimeter of such plants or within the perimeter of storage tank farms, be paid an all-purpose allowance of \$1.55 per hour extra.

This allowance will be adjusted annually in accordance with CPI (All Groups, Melbourne) movements measured in the twelve month period ending the previous December quarter effective as of 1 March 2025 rounded to the nearest 5 cents.

(f) **Service Core Allowance**

As of 1 March 2024 the Employer shall pay \$1.75 per hour for all work carried out in the construction of service core where the Employee is physically isolated from the top deck and working in an enclosed space.

This allowance will be adjusted annually in accordance with CPI (All Groups, Melbourne) movements measured in the twelve month period ending the previous December quarter effective as of 1 March 2025, rounded to the nearest 5 cents.

For a period of up to five working days, when Employees working in the service core are required to walk beyond four levels and up to a maximum of six levels, they will be paid double the Service Core Allowance.

27 Clothing Issue

27.1 Mandatory equipment

- (a) All Employees engaged to work on site will be supplied with safety footwear and safety helmets appropriate to the work that they perform before commencing work on a Project. The safety footwear will be of an equivalent standard to those made by:
 - (i) Steel Blue;
 - (ii) Oliver; and

- (iii) Mongrel Boots.
 - (b) These items must be worn at all times as instructed during the Project induction process.
 - (c) Helmets must not be painted, drilled or modified in any way. Damaged and/or worn footwear and helmets will be replaced on demand.
- 27.2 **Work clothing**
- 27.3 Two (2) sets of cotton drill protective clothing will be issued to all Employees, upon request, within two weeks of commencing work with the Employer. Employees will be made aware of these entitlements at the time of employment.
- 27.4 The following clothing will be supplied to all Employees:
 - (a) two (2) pairs of overalls; or
 - (b) two (2) combination bib and brace; or
 - (c) two (2) pairs of long trousers and two (2) long sleeved shirts; or
 - (d) work denims at cost no greater than the above three (3) choices.
- 27.5 All new Employees engaged between 1 May and 31 August will be issued with one high visibility winter jacket or agreed equivalent. Winter jackets will be replaced on a fair wear and tear basis.
- 27.6 Clothing and footwear will be replaced on a fair wear and tear basis. The Employer will replace any clothing and footwear damaged due to fair wear and tear within a reasonable period following the Employee's request. All items will comply with the relevant Australian Standards and all endeavours will be made to provide clothing that is Australian made. The clothing selected by the Employer will be required to be breathable, light weight, UV stable, have high visibility quality, and have the maximum UPF rating.
- 27.7 No agreement to pay cash in lieu of supply of clothing/footwear is permitted and the Employer should maintain a register for all protective clothing provided to Employees. Where the relevant supplier of clothing/footwear maintains a register, this will meet the requirements of this clause.
- 27.8 **Source of clothing**
 - (a) The Parties seek to provide opportunities to seeks to maximise opportunities for Australian, New Zealand and Victorian suppliers (**Local Suppliers**) to supply on the basis of best value for money for the provision of work clothing to its Employees.
 - (b) Local Suppliers of clothing will be made aware of opportunities to supply clothing to the Employer.
- 27.9 **Tools**
 - (a) The Employer shall provide on all construction jobs, and elsewhere where reasonably necessary and practicable (or if requested by the Employee), a suitable and secure waterproof lock-up solely for the purpose of storing Employees' tools, and on multi-storey and major projects the Employer shall provide, where possible, a suitable lock-up for Employees' tools within a reasonable distance of the work area of large groups of Employees.

- (b) Where an Employee is absent from work because of illness or accident the Employer shall ensure that the Employee's tools are securely stored during their absence.

27.10 Compensation for Loss of Employee Tools

The Employer will replace all Employee tools lost or stolen in accordance with the Award.

28 Higher Duties

- 28.1 Where an Employee on any one day performs two or more classes of work to which different rates of pay are applicable, the Employer shall pay to the Employee the higher hourly rate for the entire day if the Employee is required to work in that class of work for more than 2 hours, and if for less than 2 hours during any one day the Employee will be paid the higher rate for the time so worked.

28.2 Lesser Duties – Crane Crew

Where an Employee works as a member of the crane crew and there is no longer a role available to perform their typical responsibilities (i.e. the crane is no longer on the Project), the Employer may provide an alternative role under a lesser classification effective immediately provided no other Employee is made redundant to bring this to effect.

29 Payment of Wages

- 29.1 All wages, allowances and other monies may be paid by electronic funds transfer which Employee(s) may request be split between up to two accounts.
- 29.2 Wages and pay slip details shall be made available no later than the cessation of ordinary hours of work on Thursday of each working week.
- 29.3 Except for cessation of employment (see **clause 19**, waiting time shall not be payable where an Employee(s) is kept waiting for their wages due to circumstances beyond the control of the Employer (e.g. internet banking unavailable).
- 29.4 During the life of this Agreement, the Employer may by agreement between the Parties alter the pay week to commence on Monday and conclude on Sunday of each week with bank transfers to be effected by midday Thursday.

30 Wage Payment Details

30.1 Pay slips

- (a) The following particulars of details of payment to each Employee must be included on the Employees' work statement/ pay slip:
 - (i) name of the employing Employer;
 - (ii) business name, Legal name, trading name ABN/ACN;
 - (iii) name of Employee;
 - (iv) employee's classification;
 - (v) date of payment and period covered by work statement/ pay slip;
 - (vi) details of the number of ordinary hours worked;
 - (vii) details of the number of overtime hours worked;

- (viii) the ordinary hourly rate and the amount paid at that rate;
 - (ix) the overtime hourly rates and the amounts paid at those rates;
 - (x) the gross wages paid;
 - (xi) the net wages paid;
 - (xii) details of any deductions made from the wages;
 - (xiii) details of all accrued entitlements including RDO accruals, personal leave, annual leave, long service leave etc.;
 - (xiv) details of the Employer's Incolink and CBUS/superannuation contributions, including when the contribution was made and the amount, and, details of Employee contributions, including when the contribution was made and the amount;
- 30.2 Work Statement/pay slips will be issued to Employees within 2 days of payment.
- 30.3 In addition to the details of payment noted above, the Employer will also keep records of the following:
- (a) the Employee's date of birth;
 - (b) the date of commencement of employment;
 - (c) the Employee's tax file number;
 - (d) the Employee's Leave Plus number;
 - (e) details of the Employee's:
 - (f) daily start and finish time;
 - (g) time lunch and crib breaks taken;
 - (h) details of allowances paid;
 - (i) total gross allowances paid; and
 - (j) tax deducted from wages per week and year to date.
- 30.4 An Employer must not falsify pay slips or Employee records as required.

31 Inclement Weather

- 31.1 This Inclement Weather clause sets out the full rights, obligations and entitlements of the Parties and establishes the conditions under which payment for periods of Inclement Weather shall be made.
- 31.2 This Inclement Weather clause is to be read and observed in lieu of the provisions of the Award.
- 31.3 The purpose of this clause is to set out the procedures and processes which must apply concerning the suspension of work in areas exposed to Inclement Weather as defined and prescribes the conditions regulating payment of ordinary time wages for Employees who cannot be re-assigned to work out of the Inclement Weather.
- (a) **Definition**
 - (i) **Inclement Weather** shall mean the existence of rain or abnormal climatic conditions (whether they be those of hail, snow, cold, high

wind, severe dust storm, extreme high temperature or the like or any combination thereof) by virtue of which it is either not reasonable or not safe for Employees exposed thereto to continue working whilst the same prevail.

(b) **Hot weather guidelines**

- (i) Under this Agreement, temperature of or above 35°C shall be defined as constituting 'Inclement Weather' for work in the Greater Melbourne area. This definition will be subject to review in other regions.
- (ii) When it is expected that the temperature will be 35°C or more, or when the temperature approaches 35°C, the Parties on site shall confer regarding the performance of work. If work has ceased for two consecutive days due to hot weather and the Bureau of Meteorology (**BOM**) has forecast that the temperature will reach 35°C on the following day and the BOM has also forecast a cool change for that day, the Employees on site on that day will remain in air conditioned amenities for one and a half hours after the temperature reaches 35°C. If the temperature drops to below 33°C, the Employees will return to work. The Parties will also adopt this procedure for any subsequent days where the BOM forecasts that the temperature will reach 35°C or more.
- (iii) As part of a process leading to improvements, it is recognised that hot weather procedures including relocation, must be part of a formal OH&S procedures developed, adopted and managed on a Project basis having regard to the different conditions that may prevail on projects in various locations.

(c) **High Winds**

- (i) The occurrence of high winds, whilst constituting 'Inclement Weather' affecting some work processes, does not give rise to an entitlement for any Employee whose work is suspended to leave the site and be paid. Payment will not be made for time so lost. The provisions of **clauses 31.4 and 31.5** do not apply to the time any work is suspended due to the effects of high wind.

(d) **Temperature Measurement**

- (i) Temperature will be measured by the nearest automatic Melbourne Bureau of Meteorology Monitoring Station unless otherwise agreed between onsite management and Employee representatives at the commencement of each Project. If any disputation under this clause cannot be resolved at the workplace level, it will be referred to the Disputes Panel under **clause 11** of the Agreement as soon as practicable.

(e) **Working Arrangements**

- (i) The former industry practice whereby all Employees on site working in direct sunlight were relocated to shaded or air-conditioned areas when the temperature reached 32°C, will no longer operate.
- (ii) At temperatures below 35°C workers are not to be relocated out of

direct sunlight unless the work environment creates a serious risk to their health and safety, having regard to the nature of the tasks being undertaken, provided that the task or activity being performed is completed and the penalty provisions as for emergency work under the Award shall apply.

- (iii) Once the temperature reaches 35°C work will cease, and workers may leave the site, provided that the task or activity being performed is completed and the penalty provisions as for emergency work under the Award shall apply.
- (iv) During periods of hot weather, work in air-conditioned environments shall continue as normal. Workers will walk a reasonable distance through the open to and from amenities and the air-conditioned workspace, provided it does not pose a serious threat to their health or safety. Alternatively, where the Employer can artificially ventilate covered spaces onsite and reduce the temperature to below 35°C, work may continue as normal subject to consultation and agreement with affected Employees to comply with the provisions of this clause.
- (v) By agreement with the OH&S committee and head contractor during periods of Inclement Weather (heat) the Saturday break roster can be applied to weekday work.

(f) **Payment**

- (i) An Employee shall not be entitled to payment for Inclement Weather as provided for in this clause unless the Employee remains on the job until the provisions set out in this clause have been observed.
- (ii) The entitlement to payment for time lost due to Inclement Weather is an entitlement limited to ordinary time lost, and does not apply to overtime and/or weekend work. Should overtime or weekend work be suspended due to Inclement Weather, then overtime payments will cease subject to the provisions of this Agreement concerning minimum payment for Saturdays and Sundays in which case the minimum time payments as prescribed by the Agreement shall apply.
- (iii) Payment for time lost due to Inclement Weather is at the rate of Ordinary Time Earnings.
- (iv) All necessary steps shall be taken to ensure a full working understanding of the Inclement Weather standards, as contained in this Agreement, is achieved and maintained by the management and workers.
- (v) Should a portion of the Project be affected by Inclement Weather, all other Employees not affected shall continue to work in accordance with the appropriate Agreement provisions, regardless that some Employees may be entitled to cease work due to Inclement Weather.
- (vi) Where an Employee is prevented from performing their typical duties as a result of Inclement Weather, the Employer may direct the Employee to perform other productive work provided such work

is within the Employee's general scope of work per classification. This applies to all Employees on site, including members of the form worker, steel fixer, PT, concreter and crane crew. Any Employees so directed will suffer no reduction in pay and entitlements under this Agreement. For example, a CW7 Employee (crane crew) may be directed to perform materials handling tasks such as hoist, forklift, pallet jack, spotting for forklift etc.

- (vii) Employees who are required to commence work at or after the end of the ordinary day work hours and when the temperature is at or over 35°C will remain on site in air-conditioned amenities for a minimum two hours, holding themselves available to commence work should the temperature fall below 35°C.
- (viii) Prior to any Employee leaving the site due to Inclement Weather, consultation shall take place between Employee Representatives and Site Management. Any stoppage of work, or withdrawal from site, without due consultation will mean that all involved Employees are denied an entitlement to payment as per this clause.

(g) **Entitlement to payment**

- (i) An Employee shall be entitled to payment by the Employer for Ordinary Time Earnings lost through Inclement Weather for up to 32 hours in every calendar month. For the purpose of this sub-clause the following conditions shall apply:
 - (A) an Employee shall be credited with 32 hours at the commencement of each calendar month.
 - (B) the number of hours at the credit of any Employee at any time shall not exceed 32 hours.
 - (C) if an Employee commences employment during a calendar month the Employee shall be credited 32 hours where the employee commences on any working day within the first week; 24 hours where the employee commences on any working day within the second week; 16 hours where the Employee commences on any working day within the third week; and 8 hours where the Employee commences on any working day within the fourth week.
 - (D) no Employee shall be entitled to receive more than 32 hours Inclement Weather payment in any calendar month.
 - (E) the number of hours credited to any Employee under this clause shall be reduced by the number of hours for which payment is made in respect of lost time through Inclement Weather.
 - (F) payment under this clause shall be weekly.
- (ii) Provided further and subject to **clause 31.3(g)(i)(C)**, an Employee working on a part time weekly basis shall be entitled to payment on a pro-rata basis according to the number of ordinary hours agreed to be worked in the calendar month. The method of calculation of a part-time daily hire Employee's proportionate entitlement shall be as follows:

32 x (A) divided by 156

Note:

(A) is averaged hours per calendar month over a 12 month period.
(A) can be calculated by the following method: weekly part time
hours x 52 weeks divided by 12 months

156 is the average total hours per month i.e. 36 hours per week x
52 weeks divided by 12 months

Example:

Where an Employee works **20** hours per week, their Inclement
Weather entitlement would be calculated as follows:

$$(A) = 20 \times 52 \text{ divided by } 12 = 86.67$$

$$32 \times 86.67 \text{ divided by } 156 = 17.77 \text{ hours, rounded to } 18 \text{ hours}$$

The Employee is entitled to 18 hours of Inclement Weather per
calendar month. If the resultant number is 0.0 > 0.49 round down
to the nearest hour, 0.50 > 0.99 round up to the nearest hour.

(h) **Transfers**

(i) Employees may be transferred from one location on a site where it
is unreasonable to work due to Inclement Weather, to work at
another location on the same site, or another site, which is not
affected by Inclement Weather subject to the following:

(A) no Employee shall be transferred to an area not affected by
Inclement Weather unless there is work available in the
Employees' classification.

(B) Employees may be transferred from one location on a site to
work in areas which are not affected by conditions of
Inclement Weather even though there may not be work for
all Employees in such areas.

(C) Employees may be transferred from one site to another site
and the Employer shall provide, where necessary, transport.

(i) **Conference Requirement and Procedure**

(i) The Employer, or the Employer's representative, shall, when
requested by the Employees or their Employee Representative/
Union Delegate, confer (within a reasonable period of time which
should not exceed 1/2 hour) for the purpose of determining
whether or not conditions are inclement.

(ii) Provided that if the Employer or the Employers' representative
refuses to confer within such reasonable period, Employees shall
be entitled to cease work for the rest of the day and be paid
Inclement Weather.

(j) **Cessation and Resumption of Work**

(i) At the time Employees cease work due to Inclement Weather the

Employer or the Employer's representative on site and the employee's representative shall agree and note the time of cessation of work.

- (ii) After the period of Inclement Weather has clearly ended the Employees shall resume work and the time shall be similarly agreed and noted.

(k) **Safety**

- (i) Where an Employee is prevented from working at the Employee's particular function as a result of unsafe conditions caused by the Inclement Weather, the Employee may be transferred to other work in the Employee's classification on site, until the unsafe conditions are rectified. Where such alternative is not available and until the unsafe conditions are rectified, the Employee shall remain on site. The Employee shall be paid for such time without reduction of the Employees' Inclement Weather entitlement.

31.4 Requirements for Work to Continue on Sites Affected by Wet Weather

- (a) Where Employees are prevented from working because it is raining:
 - (i) for more than an accumulated total of four hours of ordinary time in any one day;
 - (ii) after the meal break, for more than an accumulated total of 50% of the remaining work time; or
 - (iii) during the final two hours of the normal working day for more than an accumulated total of one hour;

the Employer shall not be entitled to require the Employees to remain on site beyond the expiration of any of the above circumstances.

- (b) Provided that where, by agreement between the Employer and/or the Employer's representative and the Employee's representative, the Employees remain on site beyond the periods specified above, any such additional wet time shall be paid for but shall not be debited against the Employees' hours.

31.5 Rain at Starting Time

- (a) Where the Employees are in the sheds, because they have been rained off, or at starting time, morning tea, or lunch time, and it is raining, they shall not be required to go to work in a dry area or to be transferred to another site unless:
 - (i) the rain stops; or
 - (ii) a covered walkway has been provided; or
 - (iii) the sheds are under cover and the Employees can get to the dry area without going through the rain; or
 - (iv) the distance to walk to the dry area is no more than 50m (or further where agreed by the Parties) in circumstances where the amenities are temporarily located outside of the site boundary, and it is not possible to provide covered walkways.

It is acknowledged that some Projects have unique circumstances e.g. council restrictions, health and safety considerations etc. that mean that it is not possible to locate the amenities within the site boundaries for a period of time. On these Projects the parties will consult at a senior level to determine the appropriate temporary measure.

It is not the intent of this clause that Employees walk in the rain in all circumstances. Where an Employer seeks to use this provision due to the nature of a Project, they will consult with the parties as to the operation of this clause and determine an appropriate definition of "drenched". If there is a potential for the Employee to get "drenched" they will not be required to walk to the Workfront Senior levels of the union and the Employer will be involved in the implementation of this clause. This clause only applies to projects within the Melbourne CBD as bounded by Spring Street, Victoria Street, Spencer Street and Flinders Street; or

- (v) Adequate protection is provided. Protection shall, where necessary, be provided for the Employees' tools.
 - (vi) In the case of mechanical plant operators carrying out early works as the principal activity or mechanical plant demolition on a site and they have a dry cabin to work from and they can safely access their cabin without getting "drenched", they will return to work so long as the work itself is safe to perform. The Employer will ensure that other necessary personnel are provided to ensure safety of the workforce and the public.
- (b) In this clause, a dry area shall mean a work location that has not become saturated by rain or where Employees would not become wet.

31.6 **Dewatering**

- (a) **Where the whole of a site** is so affected by surface water following a period of rain that all productive work is suspended by agreement of the Parties, then dewatering shall proceed as above with Employees so engaged being paid at penalty rates as is the case for safety rectification work. This work is typically performed by Employees engaged within CW1, CW2 or CW3 classifications. When other Employees are undertaking productive work in an area or areas not so affected then dewatering will only attract single time rates.
- (b) **Where a part of a site** is affected by surface water following a period of rain, thus rendering some areas unsafe for productive work, consistent with the Employer's obligations under the OH&S Act, appropriate Employees shall assist in the tidying up of their own work site or area if it is so affected. Where required, appropriate Employees will be provided with the appropriate PPE. Such work to be paid at single time rates. Productive work will continue in areas not so affected.
- (c) To avoid any confusion any 'dewatering' time which prevents an Employee from being engaged in their normal productive work is not included in any calculation for the purposes of determining whether an Employee is entitled to go home due to wet weather (refer **clauses 31.4 and 31.5**)

31.7 Completion of Concrete Pours and Emergency Work

- (a) Except as provided in this sub-clause an Employee shall not work or be required to work in the rain.
- (b) Employees shall not be required to start a concrete pour in Inclement Weather.
- (c) Where a concrete pour has been commenced prior to the commencement of a period of Inclement Weather Employees may be required to complete such concrete pour to a practical stage and for such work shall be paid at the rate of double time calculated to the next hour, and in the case of wet weather shall be provided with adequate wet weather gear.
- (d) If an Employee's clothes become wet as a result of working in the rain during a concrete pour the Employee shall, unless the Employee has a change of dry working clothes available, be allowed to go home without loss of pay.
- (e) The provisions of **clauses 31.7(c) and 31.7(d)** hereof shall also apply in the case of emergency work where the Employees concerned and their delegates agree that the work is of an emergency nature and can start and/or proceed.

32 Training and Related Matters Training and Related Matters

32.1 The Parties to this Agreement recognise that to increase the efficiency and productivity of the Employer, a significant commitment to structured training and skills development is required. The Employer recognises its obligation to contribute to the skills and knowledge base of the industry.

32.2 The Employer will use agreed accredited training providers to provide any training contemplated by this clause to Employees in accordance with the following conditions:

- (a) assessment of Employee skills will be against those required in the nationally recognised formal training package relevant to their work. Any necessary training will be provided to attain the relevant nationally recognised formal qualification.
- (b) training provided will be consistent with the Employer's business requirements, relevant to the work of the Employees, consistent with the skills development of each Employee and with applicable national competency standards.
- (c) the Employer will provide Employees with any paid training time necessary to maintain the currency of their skills through recognition of prior learning, refresher training and verification of competency processes.
- (d) training may be taken either on or off the job with all reasonable steps being taken to conduct training in normal working hours.
- (e) if an approved training activity is undertaken during ordinary working hours, the Employee(s) concerned will not suffer any loss of pay.
- (f) all training required by the Employer will take place during an Employee's ordinary rostered hours unless agreed by the Employee and the Union. Approved training activities undertaken outside of an

Employee's ordinary hours will be paid at their Base Rate of Pay or may, with the consent of the Employer, be taken as time off in lieu of payment. Provided that the scheduling of time off must be consistent with the needs of the business and be by agreement with the Employer.

- (g) costs of training approved by the Employer will be met by the Employer (e.g. Construction Induction Training (White Card)).
- (h) the Employer will not be asked to meet the costs of training undertaken by Employees which was not approved by the Employer.
- (i) leave of absence granted pursuant to this clause will count as service for all purposes of the Award and this Agreement.
- (j) the Employer will pay for any training necessary for Employees to obtain and maintain any licences, tickets and/or registration, required for the Employee to perform work applicable to the Employee's current classification, as required by law.

32.3 To provide any training dealing with nationally recognised formal qualifications contemplated by this **clause 32 and Appendix P**, the Employer will use:

- (a) an Industry RTO or an RTO funded by the Victorian Building and Construction Industry Training Fund; or
- (b) an Industry TAFE.

32.4 An Industry RTO or Industry TAFE is an RTO or a TAFE that meets the following criteria:

- (a) training and assessment in the relevant qualification or accredited short course is delivered in accordance with the National Competency Standards or industry State-based competency standards in recognised short courses;
- (b) all structured training is aligned with the NCVET nationally agreed (or the equivalent state VET agreed hours as set out by the Victorian Training Package Purchasing Guide) nominal hours associated with the course or qualification and a documented rationale is provided when deviation from nominal hours occurs for a particular student;
- (c) where applicable, log books of practical application of skills are provided and monitored;
- (d) access to pastoral support for students is provided;
- (e) expertise in meeting the needs of a diverse cohorts of students including language, literacy, numeracy and learning needs is demonstrated;
- (f) use of online resources is restricted to use as a study tool;
- (g) no credential is assessed online unless exceptional circumstances apply; and
- (h) access is available to all plant and equipment required to successfully train and assess in the competencies to be delivered.

33 Licensed trades – recognition of prior learning

33.1 The Parties recognise the importance of the Victorian Government's proposal to introduce a new registration and licensing scheme for tradespeople that is

aimed at reducing non-compliant building work, enhancing industry accountability and encouraging skills formation.

- 33.2 If a licensing or registration of trades scheme is introduced during the life of the Agreement, the Employer commits to consulting with its affected Employees in good faith, for the purposes of establishing a framework for compliance that is fair and practical.

34 Accident Pay and Workers Compensation

- 34.1 Accident pay means a weekly payment of an amount being the difference between the weekly amount of compensation paid to the Employee pursuant to the relevant workers compensation legislation and the Employee's appropriate 36 hour rate prescribed in **Appendix B** of this Agreement (pro-rata for part time and casual Employees).

- 34.2 The Employer shall pay accident pay, during the incapacity of their Employee/s arising from any one injury, for a total of fifty-two (52) weeks - irrespective of whether such incapacity is in one continuous period or not. The calculation of the 52 weeks shall be that period of time, irrespective of whether is in one continuous period or not, during which the Employee receives a weekly amount of compensation paid pursuant to the relevant workers compensation legislation.

- 34.3 The liability to pay accident pay arises from the date of the injury or accident in respect of which compensation is payable under the said relevant workers compensation legislation and the termination of the Employee's employment for any reason during the period of any incapacity shall in no way affect the liability of the Employer to pay accident pay as provided in this clause.

- 34.4 In the event that an Employee receives a lump sum in redemption of weekly payments under the said relevant legislation, the liability of the Employer to pay accident pay as herein provided shall cease from the date of such redemption.

34.5 Employee Entitlements while on Worker's Compensation

If an Employee is absent from work and is in receipt of worker's compensation, the Employee's contract of employment shall remain intact during the period of absence, the Employer shall continue to make contributions on behalf of the Employee to all the Employee Entitlement Funds as outlined in **clauses 21 to 24** (inclusive) of this Agreement. The Employee shall also continue to accrue all appropriate leave entitlements for the entire period for which worker's compensation is in receipt.

PART 5 - HOURS OF WORK AND RELATED MATTERS

35 Hours of Work

- 35.1 Ordinary hours of work will be eight (8) hours per day, Monday to Friday with the notional weekly hours based on a 36 hour week in accordance with **clause 37**. Overtime may be worked outside of the ordinary hours of work.
- 35.2 **Starting/Finishing times**
- (a) Ordinary daily hours may be worked between the hours of 6:00 am and 6:00 pm.
- 35.3 Subject to **clause 35.5**, the Employer has the right to otherwise alter start and finish times within the spread of ordinary daily hours. Prior to altering start and finish times (other than in accordance with **clause 35.5**) the Employer will consult with the affected Employees and
- (a) provide not less than eighteen hours of notice to affected Employees of the change to start and finish times; and
- (b) have regard to the intention of avoiding excessive overtime.
- 35.4 The Parties acknowledge that during the winter months flexibility around later start times, for example 7:30am, can facilitate increased productivity on site.
- 35.5 Without limiting the Employer's rights expressed in **clauses 35.2 and clause 35.3**, where the Employer has identified that a set starting time creates problems with the efficient movement of the workforce to their workplaces, the Parties agree to consult jointly with affected Employees to establish an efficient start time regime.
- 35.6 Where a dispute arises over the Employer's exercise of the right to alter start and finish times under this clause and it cannot be resolved at the workplace level, any Party may refer the dispute directly to the Disputes Panel for conciliation and/or resolution under **clause 11** of this Agreement. All Parties will cooperate with the requests of the Disputes Panel including requests to provide substantiating information. For the avoidance of doubt, an Employee may appoint a representative in relation to such a dispute.

36 Shiftworkers

- 36.1 Shiftworker for the purposes of this clause is defined as an Employee who performs Shiftwork and who starts or finishes a shift outside of the ordinary hours set out at **clause 35.2** above.
- 36.2 A Shiftworker shall be paid at the rate of double time for all hours worked.
- 36.3 An Employee who has to work Shiftwork shall be given at least 48 hours of notice of the requirements to work shiftwork.
- 36.4 For clarity, Shiftwork, means work comprising recurring periods in which different groups of workers do the same jobs in rotation; the different groups of workers do not necessarily need to be employed by the same employer for the purpose of this definition.

37 Rostered Days Off

- 37.1 The ordinary working hours shall be worked in a ten (10) day/two (2) week cycle, Monday to Friday inclusive with eight (8) hours worked on each of nine days within the cycle and with 0.8 of an hour on each of those days accruing toward the tenth day, which shall be taken as a paid day off. The tenth day will be known as the Rostered Day Off or (**RDO**).
- 37.2 RDOs are paid at the ordinary time rate paid to Employees at the time of taking the RDO and will include the daily 'Fares & Travelling Allowance', and any applicable Site Allowance as prescribed by this Agreement.
- 37.3 For clarity, 26 RDOs will be accrued by an Employee in each twelve months continuous service. The Employer must maintain a RDO accrual system that accurately records the accrual of RDOs in accordance with this Agreement.
- 37.4 Each day of paid leave taken and any public holiday occurring during any cycle of two weeks will be a day worked for accrual purposes.
- 37.5 Upon commencement of employment, Employees who have not worked a complete ten (10) day/two (2) week cycle, will receive pro-rata accrual entitlements for the first RDO or group of RDOs falling after their commencement of employment.

An Employer and Employee may agree to RDO accruals in advance in instances where the Employee does not have sufficient RDO accruals when an RDO falls due.

- 37.6 Upon termination of employment, an adjustment will be made to ensure that the full RDO entitlements, and no more, have been provided. This means that Employees then having received more RDOs than they were entitled to will have the relevant amount removed from final termination payments, and Employees who have received less than their full RDO entitlement will have the outstanding amount added to final termination payments.

37.7 RDO Schedule/ Working Day Calendar

- (a) The Employer recognises that hours accrued in accordance with **clause 37** create a bank of hours to be drawn upon by the Employee, as a paid RDO. The Employer recognises that Employees are entitled to take off days accrued in accordance with this clause.
- (b) The agreed indicative RDO/Working Day Calendars for 2024 to 2029 are attached at **Appendix D** of this Agreement.
- (c) For the avoidance of doubt, nothing in the arrangement for an indicative RDO / Working Day Calendar is intended to impose a limit on the ability of the Employer to determine with its Employees when and where work can be performed to meet operational requirements or otherwise limit the Employer's right to manage its business and improve productivity.

37.8 Work on Scheduled RDOs

Circumstances

- (a) Work may take place on a scheduled RDO by agreement between the Parties to this Agreement or on any substituted day where it is required by the Employer and such work is necessary to meet operational requirements, manage its business and/or improve productivity subject to the below procedure.

- (b) Examples of where work may take place include, but are not limited to, the following:
- (i) to allow other Employees to be employed productively, to carry out out-of-hours maintenance; or
 - (ii) because of unforeseen delays to a particular Project or a section of it; or
 - (iii) for other reasons arising from unforeseen or emergency circumstances on a Project.

For the avoidance of doubt, unforeseen or emergency circumstances include, but are not limited to: excessive periods of Inclement Weather, matters not necessarily the fault of the Employer which has led to the Project being delayed or behind schedule, the requirement to meet the Employer's work program and unexpected delays in the Project due to scheduling of other works or supply of materials, or work that cannot be performed on other days because of municipal council restrictions, or other relevant laws or regulations.

Such requirement must be based on genuine circumstances.

Procedure

- (c) Where the Employer requires work to be performed on a Scheduled RDO (or any substituted day) because of the existence of any of the above, it will:
- (i) consult with the affected Employees and the Union within a reasonable timeframe;
 - (ii) determine that affected Employees agree to work on the Scheduled RDO; and
 - (iii) the Employer will notify and agree with the Employees and their Union representative in writing (via email prior to the RDO when work needs to be performed. The attached notification form (Appendix I) may be used for this purpose. Affected Employees will be entitled to meet with their Union Representative for the purpose of consulting about works to occur on a scheduled RDO. The attached notification form (**Appendix I**) may be used for this purpose.
- (d) The Employer is committed to providing as much notice as is reasonably practicable of a requirement to work. Wherever possible, the process outlined above will occur at least nine (9) calendar days prior to the RDO in question. An Employee may refuse to work on a scheduled RDO (or any substituted day) if the requirement to do so is plainly unreasonable having regard to:
- (i) the hours of work that will be worked by that Employee in the week of the scheduled RDO;
 - (ii) the number of scheduled RDOs worked by the Employee within the previous six weeks;
 - (iii) the Employee's family responsibilities; and

- (iv) any other special circumstances peculiar to the Employee.

Applicable Rates for Work on Scheduled RDOs

- (e) An Employee required to work who has been consulted with in accordance with the Procedure, in addition to accrued entitlements, will be paid at the Employee's Ordinary Rate prescribed in this Agreement for the Employees' classification.
- (f) An Employee required to work who has not been consulted with in accordance with the Procedure, in addition to accrued entitlements, will be paid as if they were undertaking Public Holiday Work in accordance with **clause 38.9** of this Agreement. For the avoidance of doubt, where the Employer has consulted with the Union in accordance with subclause (c) rates of pay will be in accordance with subclause (e).
- (g) For the avoidance of doubt notwithstanding that casual Employees do not accrue RDO's, any work performed by a casual Employee on an RDO will be paid at the appropriate penalty rates for full time employees plus casual loading.

Scheduled RDOs on Designated Long Weekends

- (h) It is recognised that there is merit in programming no work on the RDOs adjacent to public holiday weekends during the working year. This will allow Employees to have quality paid family leisure time.
- (i) A Designated Long Weekend (**DLW**) is a weekend where an RDO below falls adjacent to (either before or after) a public holiday.
- (j) Where work is required on RDOs which falls on a DLW, the Procedure will be followed, and agreement must be reached between the Employer and a majority of affected Employees.
- (k) An Employee required to work, in addition to accrued entitlements, will be paid as if they were undertaking Public Holiday Work in accordance with **clause 38.9** of this Agreement, for each weekend day, the public holiday and the RDO.
- (l) All Employees who work on the Scheduled RDO will be granted an alternative RDO to another day falling within six weeks of the originally scheduled day provided that the re-scheduled RDO is to be taken on a day or days adjacent to a weekend or in conjunction with annual leave, or as otherwise agreed between the Employer and the majority of its affected Employee/s, such agreement shall not to be unreasonably withheld.

Note: See also Easter and Christmas Shut Down at **clause 40.7**.

37.9 Disputes concerning the Employer's intent to work on a particular scheduled RDO

- (a) Where in accordance with the disputes resolution procedure, the Union has been advised by the affected Employees of a concern regarding the process undertaken to work on the scheduled RDO (or substituted day) it will, by close of business on the Monday following the provision of the Employer's notification, notify the Employer and the Disputes Panel of this concern.

- (b) Given the nature of the urgency of such matters, the Disputes Panel will prioritise such disputes to be heard within one (1) working day (where practicable).
- (c) Prior to the scheduled Disputes Panel hearing, the Parties may hold discussions to attempt to resolve the matter.
- (d) Where the Union fails to notify the Employer and the Disputes Panel by close of business on the Monday following the provision of the Employer's notification, work shall be performed on the scheduled RDO (or substituted day) in question unless prior to the scheduled RDO (or substituted day), the Disputes Panel has heard the matter and determined that the necessary requirements for working on a schedule RDO (or substituted day) under this clause have not been met by the Employer.
- (e) Where an Employee(s), an Employee representative or the Union have a concern over the Employer's operation of this provision, they may at any time request to review the Employer's practice. If necessary, the matter could be referred to the Disputes Panel for review.
- (f) Any such review must be independent of any particular intention to work on a scheduled RDO.

37.10 Unforeseen and Emergency Scheduled RDO work where Notice not Provided

- (a) If notice is not provided by the Employer in accordance with **clause 37.8(c)** and **37.8(d)** then the affected Employees, in addition to accrued entitlements, will be paid as if they were undertaking Public Holiday Work in accordance with **clause 38.9** of this Agreement.

37.11 Alternate RDOs

- (a) Where the Employer and a majority of the Employer's Employees at an enterprise or job site agree, another day may be substituted for the scheduled RDO.
- (b) Wherever possible, such agreement will take place 5 working days prior to the change being implemented.
- (c) Where there is a dispute in relation to an alternate RDO and it is unable to be resolved at the workplace level, the matter may be determined in accordance with **clause 11- Disputes Resolution Procedure** of this Agreement.

37.12 Banking of RDOs

- (a) Where the Employer and an Employee agree up to five (5) RDOs may be accrued for the purpose of creating a bank to be drawn upon by the Employee at times mutually agreed.

Details of such banked RDOs will be entered on to each Employee's employment records.
- (b) Where there is a dispute in relation to the operation of this sub-clause and it is unable to be resolved at the workplace level, the matter will be determined in accordance with **clause 11- Disputes Resolution Procedure** of this Agreement.

38 Overtime

38.1 Except as varied herein, overtime will be worked in accordance with the provisions of the Award.

38.2 Such overtime will be calculated by applying the divisor of 1/36th to the Employee's weekly rate as prescribed herein.

38.3 All overtime shall be paid at double Ordinary Rates.

Overtime meal allowance

38.4 Subject to the eligibility requirements of **clause 21.2 of the Award**, an Employee required to work overtime for one and one half (1.5) hours or more after working ordinary hours must be paid by the Employer an overtime meal allowance as outlined in the table below:

From the first pay period commencing on or after 1 March 2024	\$31.98
---	---------

Overtime meal allowance will be adjusted annually in accordance with CPI (All Groups, Melbourne) movements measured in the twelve month period ending the previous December quarter effective as of 1 March from 2025 onwards, rounded to the nearest cent.

38.5 Leisure Time Protected

- (a) It is the intention of the Employer and Employees that excessive overtime will not be worked.
- (b) To this end the general standard of weekly hours will usually not be more than 56 per week (Monday to Saturday) for an individual Employee, provided that the aforesaid 'usual weekly hours' may by agreement be exceeded from time to time to meet the needs of the Project, or a specific task on a Project.
- (c) Reflecting this intention, it is recognized that:
 - (i) the Employer is not restricted as to the setting of daily hours within the 56 hour standard;
 - (ii) it is acknowledged that additional hours are necessary for particular personnel (e.g. [without limiting the foregoing] crane crews; peggies; first aiders; hoist drivers; concrete finishers; site security personnel), and such situations are not affected or restricted by this provision, as they are agreed to be a normal necessity of the industry;
 - (iii) if time is lost on a Project due to any reason including (without limiting the foregoing) Inclement Weather, then such time may be made up by the scheduling of additional overtime provided that the total hours do not exceed 56 hours for the week for the individual Employee;
- (d) Nothing in this clause shall be read as to imply that payment as for 56 hours is guaranteed, and nothing in this clause shall diminish the right of the Employer to schedule a lesser weekly program of hours.

- (e) An Employee may refuse to work overtime in circumstances where the working of such overtime would result in the Employee working hours which are unreasonable having regard to matters including:
 - (i) any risk to Employee health and safety including the risk of fatigue i.e. excessive hours, exposure to noise, fumes, or any matter that can impair an Employee's ability to work safely and/or create a danger to Employees;
 - (ii) the Employee's personal circumstances including any family responsibilities;
 - (iii) the needs of the workplace or enterprise;
 - (iv) the notice (if any) given by the Employer of the overtime and by the Employee of his or her intention to refuse it; and
 - (v) any other relevant matter.

38.6 Alternative Leisure Time Protected

- (a) Subject to consultation and agreement between the Employer and the Union, a trial 5 day working week system may be introduced on a Project.
- (b) Where the parties reach agreement, the Employer will produce a calendar setting out the agreed days/hours of work.
- (c) The parties will consult regarding the ongoing operation of the 5 day working week.
- (d) The intent of an alternative 5 day working week trial will be to provide a work environment that provides greater options for families and lifestyle and improve mental health outcomes by promoting a balanced lifestyle that meets both the production needs of the Employer and the needs of the Employees.
- (e) The agreed calendar will be communicated to the workforce prior to commencement on a Project (e.g. through contract conditions or site induction materials).

38.7 Offer and Acceptance of Weekend Overtime

- (a) The Employer is committed to providing reasonable notice to Employees of an offer / cancellation of weekend overtime. To this end, notice will generally be provided prior to the normal meal break on Thursday. Where the Employer is unable to give such notice, the Employer may offer / cancel such overtime by notifying affected Employees before the finish time of ordinary hours on Friday.
- (b) Overtime will be offered on a work required basis.
- (c) Employees who accept an offer of weekend overtime will be obliged to attend. However, Employees may find themselves unable to fulfil their commitment to attend site. Such Employees will notify the Employer before the planned finishing time on Friday.
- (d) An Employee may refuse to work weekend overtime if the requirement to do so is plainly unreasonable having regard to:
 - (i) the hours of work that will be worked by that Employee in the week of the weekend overtime;

- (ii) the amount of weekend overtime worked by the Employee within the previous six weeks;
- (iii) the Employee's family responsibilities; and
- (iv) any other special circumstances peculiar to the Employee.

38.8 Minimum Payment

Overtime worked on a Saturday or Sunday will be paid for at the rate of double Ordinary Rates. Employees required to work on a Saturday or Sunday will be afforded a minimum 4 hours work, or be paid as if for 4 hours at the aforementioned overtime rates.

38.9 Public Holiday Work

- (a) For Employees other than Shiftworkers, double time and a half must be paid for any Public Holiday Work with a minimum payment of four hours.
- (b) For Shiftworkers, double time and a half (inclusive of their shift loading) must be paid for any Public Holiday Work with a minimum payment of four hours.

38.10 Work on Fridays

- (a) This clause may not apply on Projects where the Parties have agreed to implement a five (5) day working week.
- (b) The Employer and Employees will endeavour to ensure that wherever possible and subject to operational requirements, normal productive work shall cease at the finish of ordinary hours on Fridays.
- (c) Operational requirements that would require productive work to continue past this time include but are not limited to circumstances where such work will be able to continue if the work is necessary for the production schedule to be maintained or to ensure that other Employees can be productively employed.
- (d) Other circumstances where work will be able to continue include the following: to recover time lost due to excessive periods of Inclement Weather, matters not necessarily the fault of the Employer which have led to the Project being delayed or behind schedule, the requirement to meet the principal's work program and unexpected delays in the Project due to scheduling of other works or supply of materials.

Note 1: An Employee has the right to determine their representation (if any) in accordance with **Part 7** – Employee Representation of this Agreement.

39 Breaks

- 39.1 One 10-minute paid morning rest break and one 30 minute unpaid lunch break will be scheduled within 6 hours after work starts.
- 39.2 Where an Employee is required to work more than two hours overtime after the usual ceasing time of the day or shift they shall be allowed a 20 minute rest break paid at ordinary time rates prior to commencing overtime. Employees who take payment in lieu of stopping work for this break will be regarded as having worked a further 20 minutes and shall be paid at overtime rates.
- 39.3 An Employee working overtime on a Saturday, Sunday or Public Holiday shall be allowed a 30-minute combined Rest Period/Meal/Crib Break after four hours

work, such time to be paid at double ordinary time rates, with a further 20 minute Crib break to be paid at double ordinary time rates if the overtime continues past 8 hours worked.

39.4 In the case of overtime work being cancelled by the Employer at the end of the 4-hour minimum or any time thereafter, Employees will, in addition to the payments as prescribed, be paid for the 30 minutes combined Crib/Meal/Rest Period if not already taken.

39.5 If work proceeds beyond the 4 hours minimum then Employees will be paid for all time so worked.

39.6 **Minimum Break between Shifts**

- (a) Where it is necessary to work extended overtime, it is agreed that no Employee shall resume or continue to work without having had ten consecutive hours off duty between the termination of the overtime and the commencement of the Employee's ordinary work on the next day or shift.
- (b) In the event that an Employee agrees to a request from site management to resume or continue to work without having had ten consecutive hours off duty, the Employee shall be paid at double ordinary time rates until the Employee is released from duty for such period.
- (c) If the Employee has worked extended overtime on two consecutive days where they have had two ten consecutive hours off duty and in the event of any further extended overtime, the Employee shall not resume or continue to work without having had twelve consecutive hours off duty in the event that an Employee agrees to a request from site management to resume or continue to work without having had twelve consecutive hours off duty, the Employee shall be paid at double Ordinary Rates until the Employee is released from duty for such period.

PART 6 - LEAVE AND PUBLIC HOLIDAYS

40 Annual Leave

- 40.1 Employees (other than casuals) will be entitled to four (4) weeks paid annual leave per annum, provided that Continuous Shiftworkers shall be entitled to one additional week's paid annual leave.
- 40.2 An Employee's entitlement to paid annual leave accrues progressively during a year of service according to the Employee's ordinary hours of work, and accumulates from year to year.
- 40.3 The Employer must maintain a leave accrual system that accurately accrues annual leave progressively throughout the year in accordance with this Agreement.
- 40.4 Annual Leave is paid at the Ordinary Rate being paid to the Employee immediately prior to the taking of the Annual Leave, plus 17.5% loading.
- 40.5 Taking of Annual leave
- (a) Other than the Easter and Christmas Shutdown outlined in **clause 40.7**, the Employer and Employee shall seek to reach agreement on the taking of annual leave at a mutually convenient time. The Employer will not otherwise unreasonably refuse an Employee's request to take annual leave.
 - (b) The Employer cannot otherwise direct an Employee to take Annual Leave unless the Employer directs an Employee to take excessive accrued Annual Leave in accordance with **clauses 30.6 – 30.8 of the Award**.
- 40.6 **Annual Leave upon termination**
- (a) On termination of employment, the value of any accrued but untaken annual leave shall be paid out to an Employee.
 - (b) Leave loading will also apply to annual leave paid out upon termination.
- 40.7 **Easter and Christmas Shut Down**
- (a) Subject to **clause 40.7(e)**, it is agreed that annual leave is to be taken as per the agreed indicative RDO / Working Day Calendars in **Appendix D** to this Agreement.
 - (b) An Employee required to work who has been consulted with in accordance with the Procedure in **clause 37.8(c)**, in addition to accrued entitlements, shall be paid 300 percent of the hourly rate prescribed in this Agreement for the Employee's classification, for work on any day between and inclusive of Christmas Day and New Years Day and any day, between and inclusive of Good Friday and Easter Monday.
 - (c) Where the Employer decides to close a site over the Easter and Christmas/New Year period in excess of the agreed Shut Down period, the Employer shall give at least two (2) months' notice to Employees.
 - (d) Employees who do not have sufficient leave may be given Annual Leave in advance or leave without pay.

- (e) Notwithstanding anything elsewhere contained in this Agreement, the Employer may request any Employee to work during Easter and/or the Christmas period where necessary to meet operational requirements. Operational requirements include, but are not limited to, unforeseen or emergency circumstances, as well as work on essential projects such as schools, hospitals, manufacturing industry shutdowns, etc. In any such event the Employer shall recognise the individual right of Employees not to work, provided that Employees shall not unreasonably refuse such a request.
- (f) The Employer is committed to providing as much notice as reasonably practicable regarding the proposal to work. Whilst it is recognised that some circumstances may prevent the ability to provide reasonable notice, where practicable, two (2) months' notice of the intention to work over this period be provided.
- (g) Where work is required during the Easter and Christmas Shut Down, the Employer will consult, and agreement must be reached between the Employer and a majority of affected Employees.
- (h) Where the Employer seeks to perform work to ensure public safety or amenity, and/or performs essential works on community, education and/or health projects refer to **clause 40.7(e) – (g)** above.

40.8 **Cashing Out of Annual Leave**

- (a) Paid Annual Leave must not be cashed out except in accordance with an agreement under **clause 40.8**.
- (b) Each cashing out of a particular amount of paid Annual Leave must be the subject of a separate agreement under **clause 40.8**.
- (c) The Employer and an Employee may agree in writing to the cashing out of a particular amount of accrued paid Annual Leave by the Employee. An agreement this clause must state:
 - (i) the amount of Annual Leave to be cashed out and the payment to be made; and
 - (ii) the date on which the payment is to be made.
- (d) An agreement under **clause 40.8** must be signed by the Employer and Employee and, if the Employee is under 18 years of age, by the Employee's parent or guardian.
- (e) The payment must not be less than the amount that would have been payable had the Employee taken the Annual Leave at the time the payment is made.
- (f) An agreement must not result in the Employee's remaining accrued entitlement to paid Annual Leave being less than four (4) weeks.
- (g) The Employer must keep a copy of any agreement under **clause 40.8** as an Employee record.

40.9 **Public Holidays falling within Annual Leave**

- (a) If a Public Holiday, as prescribed in this Agreement, falls within an Employee's Annual Leave the Public Holiday does not constitute part of the Employee's Annual Leave and will be paid as ordinary hours.

40.10 Employee not taken to be on paid Annual Leave at Certain Times

If the period during which an Employee takes paid Annual Leave includes a period of other leave e.g. a scheduled RDO, Personal/Carer's Leave, or a period of absence for Community Service Leave, the Employee is taken not to be on paid Annual Leave for the period of that other leave or absence.

40.11 Subject to all relevant legislation, nothing in this Agreement will prevent the Parties from considering a scheme for the protection of Annual Leave entitlements via a third-party holding fund.

41 Public Holidays

41.1 Employees shall be entitled to be absent from work on the following Public Holidays:

- (a) New Year's Day;
- (b) Australia Day;
- (c) Good Friday;
- (d) Easter Saturday;
- (e) Easter Sunday;
- (f) Easter Monday;
- (g) King's Birthday;
- (h) Labour Day;
- (i) Anzac Day;
- (j) Christmas Day;
- (k) Melbourne Cup Day (or alternative days in regional areas);
- (l) Boxing Day; and
- (m) Grand Final Eve (Friday before the AFL Grand Final).

41.2 If any of these holidays in **clause 41.1** above are declared not to be holidays in Victoria, they will no longer be Public Holidays under this **clause 41**.

41.3 Any other day or part day which is declared by, or under a law of Victoria to be observed generally within Victoria or a region of Victoria, as a Public Holiday, is a Public Holiday under this **clause 41**.

41.4 If under (or in accordance with the procedure under) a law of Victoria, a day or part day is substituted for a day or part day that would otherwise be a Public Holiday because of **clauses 41.1 and 41.3**, then the substituted day or part day is the Public Holiday for the purposes of this clause.

41.5 The Employer and the Employee may agree that when ANZAC Day is on a Saturday or Sunday, a day will be substituted for that day on the next calendar working day as per **Appendix D**.

41.6 If the Employee is absent from work on the Public Holiday, the rate of pay will be the Ordinary Rate and any applicable first aid, leading hand, shift loading and other applicable all-purpose allowances.

Note: If the Employee does not have ordinary hours of work on the day that the public holiday falls, the Employee is not entitled to payment under this clause.

42 Personal and/or Carer's Leave

- 42.1 Employees (other than casual Employees) shall be entitled to paid Personal and/or Carer's Leave when they are absent from work due to:
- (a) a personal illness or injury; or
 - (b) to provide care or support to a member of the Employee's immediate family, or a member of the Employee's household due to an illness or injury affecting the member, or an unexpected emergency affecting the member.
- 42.2 Employees (other than casual Employees) will progressively accrue ten (10) days of Personal and/or Carer's leave per year of service.
- 42.3 Personal and/or Carer's Leave will be granted by the Employer subject to:
- (a) the Employee notifying the Employer as soon as practicable of the Personal and/or Carer's Leave; and
 - (b) providing to the Employer's satisfaction evidence that the Personal and/or Carer's Leave is/was justified. Such evidence may be a Doctor's certificate, or a statutory declaration where the Employer accepts it is appropriate.
- 42.4 The Employer cannot direct an Employee to take Personal and/or Carer's Leave.
- 42.5 Upon commencement of employment Employees will automatically be credited with five (5) days' Personal and/or Carer's leave in advance. After 6 months of employment, the leave will begin to accrue progressively up until it reaches 10 days at the conclusion of 12 months' employment. In subsequent years, Personal and/or Carer's Leave will continue to accrue progressively throughout each year.
- 42.6 An Employees entitlement to Personal and/or Carer's Leave accumulates from year to year.
- 42.7 If an Employee's employment is terminated and they are re-engaged by the Employer within a period of 6 months, the Employee's unclaimed sick leave from the previous engagement will continue from the date of re-engagement, unless these days have been notified to the Construction Industry Portable Sick Leave Scheme, in which case they will be available from this scheme.
- 42.8 Personal and/or Carer's Leave shall be paid at the Ordinary Rate applicable under this Agreement at the time that an Employee takes such leave.
- 42.9 Where an Employee is on Annual Leave and a situation arises whereby the Employee may access their Personal and/or Carer's Leave, the Employee will be taken not to be on Annual Leave for that period.
- 42.10 Unpaid carer's leave will be in accordance with the NES.

43 Compassionate Leave

- 43.1 This clause is intended to summarise the NES entitlement. It is not intended to replace or over-ride the NES.
- 43.2 Employees (other than casual Employees) are entitled to two (2) days' paid leave at the Ordinary Rate on each occasion where a member of their immediate family or household either dies or has a personal illness or injury

that poses a serious threat to their life, or where a child that would have been a member of the Employee's immediate family or member of the household is stillborn, or where an Employee or their spouse or de facto partner has a miscarriage. Further unpaid leave may be granted by the Employer. The Employee will provide the Employer with substantiating documentation if requested.

43.3 Unpaid compassionate leave will be in accordance with the NES.

44 Community Service Leave (other than Jury Service)

44.1 Employees are entitled to community service leave in accordance with the NES.

45 Jury Service

45.1 Subject to this clause, Employees are entitled to leave and payment for jury service in accordance with the NES and the *Juries Act 2000* (VIC).

45.2 An Employee (other than a casual Employee) called for jury service during ordinary working hours will be reimbursed by the Employer an amount equal to the difference between the amount paid by the Court and the amount of Ordinary Rate he/she would have received for the ordinary time hours for which the Employee's attendance at the Court was required up to a maximum of 10 days' pay.

45.3 The Employee will provide the Employer with proof of attendance, duration of attendance and amount received in respect thereof.

46 Parental Leave

46.1 Consistent with **clause 7** of this Agreement (Diversity and Inclusion), the Parties support the promotion of women into the industry and shall discuss means to achieve this objective, including ways to encourage and assist women to seek and maintain employment in the construction industry.

46.2 The Parties commit to considering any recommendations provided by relevant industry working groups (with representatives from Employer Associations and the Union) in relation to the provision of parental leave entitlements.

46.3 Parental Leave shall be in accordance with the NES including that after twelve (12) months of continuous employment, an Employee may take up to twelve (12) months of unpaid leave, if the Employee has or will have a responsibility for the care of a newborn or newly adopted child.

In addition, if the Employee is entitled to and takes paid parental leave, including shared leave, under the *Paid Parental Leave Act 2010* (Cth) (PPL Act) the Employer will pay to the Employee the difference between the amount paid to the Employee pursuant to the PPL Act for any such leave taken and the rate of pay for the Employee's commensurate classification under the Award.

47 Family and Domestic Violence Leave

47.1 For the purposes of this clause, "family and domestic violence" and "family member" and "close relative" are defined in the NES.

47.2 Confidentiality

(a) Under the NES, the Employer must take all reasonable measures to ensure personal information concerning an Employee's experience of

family and domestic violence is kept confidential. This includes complying with the obligations under the Fair Work Act and the *Fair Work Legislation Amendment Regulations 2022* regarding the recording of family and domestic violence leave on pay slips.

47.3 Leave

- (a) An Employee experiencing family and domestic violence will have access to ten (10) days per year of paid family and domestic violence leave paid at the Employee's full rate of pay. Family and domestic violence leave is available upon the Employee's commencement of employment and resets at the start of each twelve (12) month period of the Employee's employment. This form of leave may be used to, for example, attend legal proceedings, counseling, and appointments with a medical or legal practitioner, relocation, the making of safety arrangements and other activities associated with the experience of family and domestic violence.
- (b) Family and domestic violence leave is in addition to any other existing leave entitlements, and may be taken as a consecutive ten (10) day period, a separate period of one or more days, or separate periods to which the Employer and Employee agree, including periods of less than one day.
- (c) The Employee must give the Employer notice of the taking of leave under this clause as soon as practicable.
- (d) In addition, the Employer may require the Employee to produce evidence that would satisfy a reasonable person that the leave is taken in accordance with s 106B(1)(b)-(1)(c) of the Fair Work Act. Such evidence may include a document issued by the police, a court, a doctor (including a medical certificate), a family violence support service, or a statutory declaration.
- (e) For the avoidance of doubt, family and domestic violence leave does not cumulate from year to year and is not paid out on termination of employment.

48 Picnic Day

48.1 The Parties agree that Building Industry Picnic Day will continue to apply during the life of this Agreement in accordance with the following:

- (a) The first Monday in December of each year shall be the building industry picnic day, except in Mildura. The second Monday in December shall be the building industry picnic day within an area of 25 kilometres from Mildura.
- (b) All Employees shall, as far as practicable, be given and shall take this day as Picnic Day without deduction of pay.
- (c) Any Employee required to work on this day shall be paid at the rate of double time and a half; provided that an Employee who attends for work as required on this day shall be paid for not less than four hours work.
- (d) The Employer may require from an Employee evidence of their attendance at the picnic and the production of the butt of a ticket issued for the picnic shall be sufficient evidence of such attendance. Where such evidence is requested by the Employer payment need not be made

unless the evidence is produced. This requirement only applies so long as all Employees remain eligible to obtain a ticket for Picnic Day regardless of whether or not they are a Union member.

PART 7 - EMPLOYEE REPRESENTATION

Clauses 49, 50 and 51 of this Agreement outline the rights for Employee representatives and Union Delegates when assisting Employees. For clarity, each Employee has the right to determine whether they wish to be represented by a Union Delegate, Employee Representative, another representative of their choosing, or not at all.

Such representatives (or individual Employees) are entitled to the protections of Division 4 of Part 3-1 of the Fair Work Act in relation to their involvement in lawful industrial activities.

49 Representation

- 49.1 The Parties recognise the role of the Employees' on-site representative has in seeking to ensure industrial harmony on the site or at the workplace. Further the Parties recognise that the on-site representative is a first point of contact for an Employee who has an employment related grievance or a grievance, query or concern arising under the terms of the Agreement.
- 49.2 A Union Delegate/Employee Representative shall, upon notification to the Employer, be recognised as an accredited representative of the employees and, if an employee seeks representation by the representative, that representative will be allowed all necessary time during working hours to submit to the Employer employment related matters affecting the employees he/she represents. At all other times the Union Delegate/Employee Representative will perform productive work within their range of qualifications and competence. Further, the Union Delegate/Employee Representative shall be allowed reasonable time during working hours to attend to such matters affecting the employees including the right to attend appropriate meetings, Disputes Board hearings, FWC hearings and the like.
- 49.3 The Parties recognise that Union Delegates may be involved in assisting Employees where requested pursuant to the dispute resolution procedure of this Agreement.

50 Union Delegate Rights

- 50.1 To the extent that the provisions of clause 36A of the Award may confer a more favourable benefit upon a workplace delegate than the explicit terms of this clause, those provisions will operate as terms of this clause.
- 50.2 Where an Employee has been elected as a Union Delegate, the Employer will recognise the following rights:
- (a) the right to be treated fairly and to perform their role without any discrimination in their employment;
 - (b) for the Union Delegate to represent an Employee when requested in relation to a grievance, dispute or a discussion with a member of the Union;
 - (c) the right to place information on a notice board in a prominent location in the workplace except that the material must not breach freedom of association, privacy and other applicable laws;

- (d) the right to paid time to attend industrial tribunals and/or courts where they have been requested to do so by an Employee (which may include themselves) whom they represent in a particular dispute in their workplace;
- (e) the right to paid time to assist and represent Employees who have requested them to represent them in respect of a dispute arising in their workplace;
- (f) the right to represent the interests of members in their workplace to the Union, Employer and industrial tribunals/courts; and
- (g) the right to paid time to attend Union meetings for the purposes of the Union and Project related matters, typically monthly or as reasonably required.

50.3 Union Delegates will be paid the classification rate applicable to their substantive role taking into consideration their skills and/or tickets.

50.4 The Employer will consult and agree with the Union prior to the Employer making a decision to terminate or transfer a Union Delegate/Employee Representative. The Union Delegate/Employee Representative is entitled to one week's notice in advance of such termination or transfer. Payment in lieu of notice may be made by agreement.

51 Union Delegate/Employee Representative Facilities

51.1 Union Delegate/Employee Representative Facilities

The Employer shall provide an agreed facility for the use of the Union Delegate/ Employee representative to perform their duties and functions as the on-site representative of the Employees. The provision of the following facilities is to ensure that the Union Delegate/Employee Representative is able to effectively perform their functions in a professional and timely manner. The facilities shall include but need not exceed:

- (a) a telephone;
- (b) a table and chairs
- (c) a filing cabinet;
- (d) air-conditioning/heating;
- (e) access to stationery and other administrative facilities use of e-mail, (if available on site), following consultation between the Union Delegate/Employee Representative and Site Management.
- (f) a private lockable area
- (g) access to a computer.

52 Industrial Relations Training Leave

52.1 Union Delegate/Employee Representative shall have access to industrial relations training in accordance with **Appendix E** hereof.

53 Tool Box Meetings

53.1 Tool Box Meetings are regarded as an important part of site based communications. The Employer will develop a program of consultation with its

site based Employees around safety, productivity, constructability and methodology.

- 53.2 At least one toolbox meeting will be convened by the Employer per site, each month to facilitate and foster communication and consultation. Items to be discussed at each meeting may include but are not limited to programming of site work, site issues, work health and safety, job design, productivity issues, management policies, Agreement compliance, wages and conditions, compliance with statutory obligations and any other relevant issue raised. Notice of the meeting will be given at least one (1) week prior to the scheduled date, but can be rescheduled to accommodate site requirements. There will be a standing invitation for representatives of the Union to attend such toolbox meetings. Meetings will be scheduled so as to minimise disruption to production.

54 Right of entry

- 54.1 The Parties to this Agreement acknowledge the regulation of Union entry to workplaces under the Fair Work Act and the OHS Act and recognise their obligation to comply with the requirements of these laws when rights are being exercised under that legislation. The Parties to this Agreement recognise that nothing in this clause can deprive any Party to this Agreement of their rights or remedies under the Fair Work Act and OHS Act.
- 54.2 Accordingly, nothing in this clause is intended to provide for an entitlement:
- (a) to enter premises for a purpose referred to in section 481 of the Fair Work Act;
 - (b) to enter premises to hold discussions of a kind referred to in section 484; or
 - (c) to provide for the exercise of a State or Territory OHS right, other than in accordance with Part 3-4 of the Act.
- 54.3 The Employer will not:
- (a) refuse or unduly delay entry onto a site by Union officials who are entitled to enter the site in accordance with the Fair Work Act and/or the OHS Act;
 - (b) intentionally hinder or obstruct such Union officials; or
 - (c) otherwise act in an improper manner toward such officials.
- 54.4 The Union will upon entry to a Project:
- (a) be wearing all suitable personal protection equipment required for that site;
 - (b) identify themselves, including their full names, on request by the Employer, provided that such requests are not repeated unreasonably;
 - (c) sign their names in the visitor's book, or any other sign in book at a designated location on site (Sign In Book);
 - (d) have undertaken or agree to undertake the applicable site visitor induction, so as to ensure that they are aware of specific safety requirements at that site at the time of the visit, as required by site management; and

- (e) comply with all reasonable occupational health and safety requirements that apply to the site.
- 54.5 An official of the Union may have access to the Employer's premises, at any time, for the following purposes connected to this Agreement:
- (a) to represent Employees under any term of this Agreement which creates a right to representation;
 - (b) to deal with disputes and represent Employees under **clause 11**– Dispute Resolution Procedure of this Agreement;
 - (c) to represent Employees and meet with the Employer about the negotiation of a replacement agreement;
 - (d) to attend induction meetings for new Employees;
 - (e) for any other purpose connected to the relationship between the Union and the Employer, subject to the provisions of this clause.
- 54.6 Union officials may enter a site at the invitation of the Employer for other purposes. An invitation of a Union Official on site will be for the agreed purpose and minimize impact to productivity and not lead to undue interruptions to work.

PART 8 - SAFETY

55 Safety Objectives

- 55.1 The Parties recognise the potentially hazardous nature of the construction industry. To this end, the Parties to the Agreement are committed to continuous improvement in occupational health and safety standards through the implementation of an organisational framework which involves all Parties in protecting Employees' health and safety.
- 55.2 In meeting these objectives, the Parties have agreed to consider a broad agenda through the consultative processes established by this Agreement. Such an agenda will include:
- (a) measures designed to include the safe operation of plant and equipment;
 - (b) training issues including specific hazards, health and safety systems, and site induction;
 - (c) management of occupational health and safety through a comprehensive approach which aims to control hazards at their source, reduce the incidence and costs of occupational injuries and illnesses; and
 - (d) risk of fatigue (see **clauses 38.5** and **38.6**).
- 55.3 The Employer will comply with all relevant work health and safety legislation, including the OHS Act, workers compensation legislation, regulations, codes of practice and relevant and appropriate Australian and Industry Standards produced or recognised by WorkSafe Victoria.

56 Inductions

- 56.1 Prior to first attending the site, all Employees shall have successfully completed the Basic Site Induction (**Construction Induction Card**) course conducted by a RTO. Employees shall provide proof evidencing same if requested.
- 56.2 All new Employees who have not obtained a Construction Induction Card will be required to undertake an attendance based course within 28 days where reasonably practicable.
- 56.3 In addition, all new Employees of the Employer will be properly informed by Management of:
- (a) the Rights and Obligations of this Agreement including its disputes/grievance resolution procedures;
 - (b) the appropriate issue of work clothing and safety equipment as per this Agreement; and
 - (c) Employer Safety Rules and Procedures including relevant legislation.
- 56.4 Furthermore, all new entrants to a particular Project will receive an induction to the particulars and peculiarities of that site. In order to achieve this it is recommended that, all persons performing or supervising work who are new to the site shall be given an explanation of the following by Site Management:
- (a) site safety rules and procedures including relevant legislation;
 - (b) site-specific matters such as security procedures etc.

- (c) Employees must complete site inductions whilst on-site, during ordinary hours of work.

56.5 The induction presentation and material shall have regard to the language skills of the employee/employer.

57 Electronic Site Access Control

57.1 System Use

- (a) An electronic site access system may be used on site, subject to the requirements of this statement.
- (b) The system operates via:
 - (i) a facial recognition device; and
 - (ii) an electronic gate.
- (c) The system will be installed at the access and egress point/s of the site and will only be utilised to identify presence on site.
- (d) The purpose for which the electronic site access system will be implemented is to ensure:
 - (i) avoiding unauthorised access to site;
 - (ii) confirmation and co-ordination of effort in emergency situations; and
 - (iii) confirmation that all entrants to site have received a site specific induction;
- (e) The only personal data collected by the system is a site entrant's:
 - (i) image;
 - (ii) first & last name;
 - (iii) mobile phone number;
 - (iv) email address; and
 - (v) employer's name.

(the Collected Data)
- (f) The Collected Data will only be held or used for the purposes specified above, unless otherwise by consent or required by law.
- (g) The Employer will not use the electronic site access control system to verify who was on a site at a particular time for the purpose of:
 - (i) evaluating whether a variation claim regarding labour costs made by a subcontractor can be substantiated;
 - (ii) taking disciplinary action against an Employee, or assisting a subcontractor to take disciplinary action against its own employees, regarding their start and finish times; or
 - (iii) otherwise generally tracking a worker's movements whilst on the site.

57.2 Access to Collected Data

- (a) Upon written request, workers will be provided with the Collected Data relevant to them. A worker can authorise their nominated representative in writing to request and access this data on their behalf.

57.3 Definitions

- (a) "Cloud" means the practice of using a network of remote servers hosted on the internet to store, manage and process data, rather than the Employer's local server.
- (b) "Personal data" means data that allows the identification of the identity of a worker.

57.4 Requirements

- (a) Without limiting its obligations under the Privacy Act 1988 and Surveillance Devices Act 1999 (Vic), the Employer must comply with the following requirements in order to utilise, and continue to utilise an electronic access control system:
- (b) Upon written request, employees will be provided with personal data relevant to them. The request must be reasonable in the circumstances, with the reason(s) for requiring the data set out in writing. The Employer will not refuse any reasonable request. An employee can authorise his or her nominated representative in writing to request and access this data on his or her behalf.
- (c) Where a reasonable concern exists regarding any potential unauthorised access to personal data within the Employer or by a third party (for example, a supplier of technology software):
 - (i) the Employer will have; or
 - (ii) where it is a third party, the Employer agrees to take all reasonable steps to require the relevant third party to allow;

An IT auditor, to perform external penetration tests relating to the personal data. A copy of the report will be provided to the affected Employees.

57.5 Dispute Resolution Procedure

Any disputes regarding this clause or any matter relating to the use of an electronic access control system shall be dealt with under **clause 11** - Disputes Resolution Procedure.

57.6 Right of Entry

This clause in no way deprives any Party of their rights under **clause 54** - Right of entry.

58 Health and Safety Representatives

58.1 The Employer and its Employees will comply with **Part 7 of the OHS Act** – Representation of Employees in relation to the establishment of designated work groups and the election of Health and Safety Representatives.

58.2 The Health and Safety Representative/s shall be elected by the Employees on the job on a democratic basis, and shall be subject to recall by a similar process.

- 58.3 Parties covered by this Agreement recognise the important role of Health and Safety Representatives. The Health and Safety Representatives have a key role in the early intervention in health and safety issues under this Agreement.
- 58.4 The Health and Safety Representative/s shall be allowed to consult with the principal contractor, or persons acting on their behalf, on matters directly concerned with safety of workers, and promote the safe conduct of work generally.
- 58.5 The Parties acknowledge that the Health and Safety Representative has a right under **section 58 of the OHS Act**.

59 Health and Safety Representative Meetings

- 59.1 A Health and Safety Representative will be allowed reasonable paid time during working hours to attend to on the job occupational health and safety matters affecting Employees he/she represents providing that the Representative informs their manager and agreement is reached. At all other times the Health and Safety Representative will perform productive work within their range of qualifications and competencies.

60 Procedure with Dealing with Safety Issues or Incidents

- 60.1 This procedure shall be followed in good faith and without unreasonable delay. If an issue is not settled by observance of this procedure, or if the procedure is disregarded by either party, the matter will be dealt with in accordance with **clause 11** of this Agreement.
- 60.2 Nothing in this Agreement shall take precedence over the OHS Act.

60.3 Procedure for reporting issues

- (a) If an Employee wishes to raise a health and safety issue in a workplace, that Employee must report it to the Health and Safety Representative or to the Employer's Site Safety Supervisor or another management representative.
- (b) An Employee may take all steps that are necessary, including leaving the Employee's part of the workplace, to report an issue.
- (c) If the Employer's Site Safety Supervisor identifies a health and safety issue they must report it to the Health and Safety Representative.

60.4 Procedure for resolving issues

As soon as possible after an issue has been reported, the Employer's Site Safety Supervisor or another management representative and the Health and Safety Representative must meet and try to resolve the issue.

The resolution of the relevant issue must take into account any of the following factors that may be relevant-

- (a) whether the hazard or risk can be isolated
- (b) the number and location of Employees affected by it;
- (c) whether appropriate temporary measures are possible or desirable;
- (d) whether environmental monitoring is desirable;
- (e) the time that may elapse before the hazard or risk is permanently corrected;

- (f) who is responsible for performing and overseeing the removal of the hazard or risk.
- 60.5 If any party involved in the resolution of the issue requests, the details of the issue and all matters relating to its resolution must be set out in writing by the Employer to the satisfaction of all Parties.
- 60.6 As soon possible after the resolution of an issue, details of the agreement must be brought to the attention of affected Employees in an appropriate manner.
- 60.7 **Direction to cease work**
- (a) If -
 - (i) an issue concerning health or safety arises at a workplace or from the conduct of the undertaking of an Employer; and
 - (ii) the issue concerns work which involves an immediate threat to the health or safety of any person; and
 - (iii) given the nature of the threat and degree of risk, it is not appropriate to adopt the processes set out in **clause 60.4**.the Employer or the Health and Safety Representative for the designated work group in relation to which the issue has arisen may, after consultation between them, direct that the work is to cease.
 - (b) During any period for which work has ceased in accordance with such a direction, the Employer may assign any Employees whose work is affected to suitable alternative work.
- 60.8 **Inspector may be requested to attend workplace**
- (a) If an issue is not resolved under **clause 60.4**, within a reasonable time, or an issue is the subject of a direction under **clause 60.7** that work is to cease, any of the Parties attempting to resolve the issue may ask the WorkSafe Victoria to arrange for an inspector to attend at the workplace as soon as practicable to enquire into the issue.
 - (b) If -
 - (i) the inspector issues a prohibition notice; or
 - (ii) otherwise determines that there was reasonable cause for Employees to be concerned for their health or safety-
an Employee who is not assigned suitable alternative work pursuant to **clause 60.7(b)**, and who as a result of the issue arising, does not work for any period pending its resolution but would otherwise be entitled to be paid for that period continues to be entitled to be paid for that period.
- 60.9 **Rectification of Safety Hazard**
- (a) Where, because of the existence of a safety hazard, a site has been stopped for a defined period of time and Employees sent off site by agreement between Site Managers and any combination of Union Official/s, Health and Safety Committee, those people who remain on

site to do rectification work will be paid at the rate of double time for all such work.

- (b) This would not be applicable on normal de watering (see **clause 31.6** hereof) or normal housekeeping work or where a section of the site has been declared unsafe and normal rectification occurs whilst the remainder of the site carries on working. It is agreed that any 'housekeeping' work performed on Projects is to be paid at single time rate.

60.10 **Sabotage**

- (a) Sabotage is of concern to all Parties involved on any work site and may affect safety, and therefore both the physical and mental wellbeing of all persons on site.
- (b) The Parties to this Agreement will not tolerate sabotage and will ensure that any person/s responsible for such action is immediately dismissed.
- (c) It is accepted that the relevant authorities may have to be notified, and provisions of the OH&S Act implemented.
- (d) In the event of a reasonable suspicion or proven sabotage consultation will occur between the Parties on a reasonable time frame up to a maximum of 4 hours to rectify the issue prior to Employees leaving the Project.

61 **Site Safety Supervisor**

- 61.1 On every job site, where the Employer is the principal contractor it shall appoint a management representative responsible for safety (**Site Safety Supervisor**). The Employer will ensure the Site Safety Supervisor has the necessary authority to ensure that all safety laws, procedures or Codes of Practice are observed, and that the following Safety Agreement is applied.
- 61.2 The Employer when appointing the person appointed as the Site Safety Supervisor must ensure that person has and maintains the appropriate experience and knowledge of the safety requirements of the work being performed. Other duties may be assigned by the Employer to a Site Safety Supervisor, provided that such duties shall not prevent him/her from exercising their duties as a Site Safety Supervisor.

62 **Safety Committee**

- 62.1 Where a Health and Safety Committee is established on a job in accordance with **section 72 of the OHS Act**, it shall include the Employer's Site Safety Supervisor and the Health and Safety Representative/s.
- 62.2 The Health and Safety Committee may, by agreement, include additional Workers' Representatives and Employer Representatives of significant sub-contractors.
- 62.3 The Health and Safety Committee shall meet at least once every three (3) months and otherwise as often as is necessary to provide an overview of safety on the job, and assist in the promotion of a safe working environment on the job site.
- 62.4 The Safety Committee shall minute the meetings and determine an action plan for the rectification of unsafe items.

63 Training for Health and Safety Representatives

- 63.1 All duly elected Health and Safety Representatives shall be allowed to attend training and information sessions subject to the same requirements as those contained in **Appendix E** hereof so that Health and Safety Representatives are kept abreast and fully informed in the provision and maintenance of the highest possible Health and Safety Representatives standards.

64 Personal Protective Equipment

- 64.1 While not being part of any issue of work clothing/equipment supplied (see **clause 27**), the Employer shall be required to provide personal protective equipment (SAA approved) for use, when necessary for the Employee to perform their required duties including:
- (a) ear/hearing protection;
 - (b) gloves; and
 - (c) skin protective cream/sun screen (30+/50+ rating).
- 64.2 In addition, one pair of UV-rated safety glasses or UV-rated clip-ons suitable to overlay prescription spectacles, shall be made available for Employees who are required to work on reflective surfaces such as:
- (a) metal decking;
 - (b) large concrete slabs exposed to sunlight;
 - (c) roofing; and
 - (d) curtain walling.

65 Additional Safety provisions (Heavy Materials, Stand-By Drivers and Crane Crews)

65.1 Heavy Materials

An Employee shall not be required to lift a building materials in excess of 20 kg in weight unless such Employee is provided with a mechanical aid or with an assisting Employee; provided that an Employee shall not to manually lift any building materials in excess of 20 kg weight to a height of more than 4 feet (1.2m) above the working platform.

65.2 Crane Erection & Jumping

- (a) Cranes and man/material hoists may be erected, altered, climbed and dismantled during times when ordinary production works are in progress subject to the work being done in full compliance with a relevant operational safety zone (**OSZ**) plan which has been developed specifically for that operation with consideration to overall site safety.
- (b) The crane crew for each tower crane (**Crane Crew**) must consist of the following:
 - (i) crane driver; and
 - (ii) three (3) dogmen.
- (c) In addition to the appropriate tickets held by the crane driver and the dogmen, the following high risk licences must be held amongst the Crane Crew:

- (i) rigging; and
- (ii) material handling.
- (d) Where a Project consists of a single Crane Crew, the Employer should endeavour to ensure another member of the Crane Crew holds a crane driver licence.

65.3 Materials and passenger lifts will be provided in accordance with **Appendix F**.

65.4 The Parties recognise that in the interest of the Employees' safety and wellbeing tower Crane Crew will not be required to climb more than 30 metres wherever possible. Where such a requirement exists, a hoist access to the crane must be provided. However, the Parties accept that from time to time there will be occasions where an alternative arrangement will need to be implemented.

66 Drug and Alcohol Policy

66.1 The Parties agree to apply the Drug and Alcohol Management Program (as amended from time to time) contained in **Appendix G**.

66.2 The Employer may refer an Employee affected by drugs or alcohol to the services provided by Incolink.

67 Drug and Alcohol Awareness Training

67.1 The Employer must schedule one-hour long site toolbox per Project to increase drug and alcohol awareness. The toolbox must be scheduled during working hours.

67.2 Employees will be paid their normal rate including all allowances while attending the toolbox provided by this clause.

67.3 The drug and alcohol awareness toolbox must include information about drug and alcohol rehabilitation and treatment services available to Employees.

67.4 The preferred training provider is ADA Australia, however an alternate training provider may be used by the Employer provided that the training provider must have demonstrated experience and expertise in delivering drug and alcohol awareness training.

68 Safe and Respectful Workplace

68.1 The Parties recognise that everyone is entitled to work in an environment that is free of discrimination, harassment and bullying. It is the Employer's responsibility to ensure it complies with relevant legislative requirements including the *Equal Opportunity Act 2010 (Vic)*.

68.2 Accordingly, the Parties agree to the Sexual Harassment principles and the Respect Code in **Appendix J**.

68.3 In accordance with those principles the following points will be covered in the Employer's on site induction:

- (a) It is everyone's responsibility to respect women's right to work without having to experience unacceptable behaviour.
- (b) Disrespectful actions and behaviours which express power inequalities between women and men and cause physical, sexual, psychological or economic harm to women are unacceptable on site.

- (c) Unacceptable behaviours that women face in the workplace include:
 - (i) stalking and intimidation;
 - (ii) threats and verbal abuse;
 - (iii) ostracism;
 - (iv) rude gestures and put downs;
 - (v) offensive language and imagery;
 - (vi) sexual innuendo / insinuations;
 - (vii) sexual suggestions and/or unwanted advances; and
 - (viii) sexual assault.
- (d) These behaviours at work present serious OHS risks which may cause significant physical and psychological injury.
- (e) This respect must also be extended to other visitors to the site and members of the public.

PART 9 - AGREEMENT MATTERS

69 Union Flag

- 69.1 Where the Employer is the principal contractor, it agrees that on each Project the Union will be permitted to install a Union flag. The Employer will also not object to the display of a Union flag on Projects where it is not the principal contractor.

70 Posting of Agreement

- 70.1 To ensure that the Parties are aware of the terms of the Agreement, and to assist in any resolution of a disputes or the avoidance thereof a copy of this Agreement shall be retained by the Employer at all times for ready access by any Employee on a Project site or via access to the Employer's intranet, and the Employer will provide a permanent copy for each Union Delegate or Employee representative and Health and Safety Representative on a Project site.
- 70.2 The Employer will provide the Employee with an online link to the Agreement accessible via the FWC website.

PART 10 – SITE ISSUES

71 Amenities

71.1 Maintenance of Amenities

The parties acknowledge that a well maintained amenities area is important for the safe operation of a Project.

71.2 Where the Employer is the Principal Contractor on a Project, they will ensure that amenities are in good working order, clean, safe and accessible. This includes by ensuring:

- (a) dining benches are sanitized;
- (b) consumable items are replenished regularly;
- (c) toilets are cleaned regularly;
- (d) any waste is removed regularly and pest control managed appropriately; and
- (e) walkways are kept clear of obstructions.

71.3 The Parties agree that it is the responsibility of the Head Contractor/ Principal/ Occupier of a Site to ensure that the amenities prescribed by the Code of Amenities are provided as a minimum. Where, however, that standard is not maintained due to an action or event beyond the control of the Employer, the Employer should be allowed reasonable time in which to rectify the problem.

71.4 In all instances, the following procedure shall be observed:

- (a) a uniformly high standard of amenities and facilities such as ablution blocks, change rooms, crib sheds, etc., shall be provided.
- (b) where there is an issue relating to amenities, the immediate concern must be to rectify the issue. A reasonable period will be allowed to any Employer alleged to have committed a breach, to comply with all requirements of this clause. While steps are being taken to rectify the issue, there shall be no bans or limitations restricting the Employer's ability to rectify the issue.

71.5 Mess/Change Shed Facilities Dimension/Construction Requirements and Construction Sheds.

- (a) all Sheds shall be weatherproof and soundly constructed to an approved standard with sufficient windows and doors, adequate ventilation and lighting. They must have a floor above ground level and be lined on ceilings and walls.
- (b) mess shed/s fitted with fly screens are provided for exclusive use of workers and not for the storage of Employers' equipment, tools and materials.
- (c) shed/s shall provide not less than 0.75 square metres of floor space per person employed at any one time, provided that the area be not less than 4.65 square metres. Fixtures, other than tables and chairs, shall not be included when calculating floor space.

- (d) where 5 or more persons are employed at one time, the floor area shall not be less than 9 square metres.
- (e) adequate facilities are to be provided for warmth and for drying clothes e.g. strip heaters.
- (f) provided that 20 or more persons are employed on site at any one time, the Employer shall provide a separate shed or sheds for messing, which shall be of such dimension as to provide not less than 0.75 square metres of floor space per person.
- (g) first aid facilities will be maintained at the highest standard and kept clean at all times.

71.6 Contents

- (a) In the changing facilities, separate clothes hanging facilities for each person employed are to be provided (coat hooks only to be used).
- (b) In the changing facilities, sufficient seating accommodation for the changing of work apparel is to be provided.
- (c) In the messing facilities, sufficient tables with fixed washable laminex or vinyl surface, and seating for the taking of meals, are to be provided.
- (d) Food warming facilities to be supplied, together with a supply of cool, clean water conveniently accessible, as well as boiling water, tea, milk, coffee and sugar at all meal/rest breaks.
- (e) Receptacle for garbage with bin liner and rat and fly proof is to be supplied in mess area, and emptied regularly.
- (f) A washable vinyl floor surface in all facilities is to be provided.
- (g) Shelving is to be supplied in the mess shed for storage (cups, lunch bags, etc.).
- (h) All facilities are to be cleaned and disinfected twice daily.
- (i) The amenities must be separated from office space and must not be used for equipment storage.

71.7 Sanitary Facilities – Construction

- (a) Closets shall be soundly constructed and roofed with weatherproof material. The floor of each closet shall be well drained and constructed of concrete, bricks and cement, or of other approved materials which shall be impervious to water. Every closet shall be well lighted by natural or artificial light and shall be ventilated. Each closet shall have a hinged door, capable of being fastened on the inside, lift seats/flaps and toilet paper.
- (b) If closets are of single unit construction (only to be used for the formwork process), not contained within a purpose built ablution block, privacy walls which shield the closet/s from outside view shall be installed. (Privacy walls are not required for purpose built ablution blocks eg ATCO huts).
- (c) Where practicable, toilets to be connected to sewerage before commencement of the job.

- (d) Closet/urinal location to be conveniently accessible to Employees, but not so close as to cause a nuisance to those persons.
- (e) Where necessary, portable water seal toilets of an approved standard are to be provided and regularly serviced.
- (f) Conveniently accessible closets and urinals are to be distributed every 5th floor on multi storey constructions.
- (g) Closets and urinals are to be washed daily with disinfectant and kept in clean, hygienic condition.
- (h) Adequate washing facilities, suitably drained, and wash basins/troughs are to be supplied with hot and cold running water.
- (i) Soap and towels are to be supplied.
- (j) Sanitary products will be provided by the Principal Contractor for any employee as requested.

71.8 Closet / Urinal Requirements

Employees	Closets	Urinals
1-5	1	Nil
6-10	1	1
11-20	2	2
21-35	3	4
36-50	4	6
51-75	5	7
76-100	6	8

71.9 For each additional 20 persons or part thereof up to 200 persons, one additional urinal and one additional closet is required. For each additional 35 persons or part thereof in excess of 200 persons, one additional urinal and one additional closet is required. If a slab urinal is provided, each 600-mm shall be regarded as one urinal.

72 Amenities for Females

72.1 At a minimum, the following amenities must be provided on each site for female workers:

- (a) a separate ablution block, change room and closet with sanitary bin and privacy closure must be provided for female use only.
- (b) on any site with less than 10 workers of which two or less are females a separate female portable toilet (with sanitary bin) will be provided solely for the use of the females.
- (c) Upon request, an appropriate private room with a fridge for use as a lactation room.

72.2 In determining the location of the amenities the Employer must consider the most appropriate balance of privacy, safety and security.

72.3 If the female workers and the site management agree that a better alternative is available, then that alternative may be adopted.

72.4 Any site where the anticipated number of workers will be greater than 10 then the amenities for female will include a separate toilet (with sanitary bin) from the commencement of the Project.

72.5 Where, as a result of consultation, a need for a feeding room is required then such a room will be provided.

73 Site Issues

73.1 Site Record Keeping

The Employer will maintain a current record of all Employees and sub-contractors on site.

PART 11 – INDUSTRY MODERNISATION

74 Workplace Modernisation

74.1 Commitment to Continuous Improvement

- (a) The Parties are committed to continuous improvement in the general building and construction industry and to the modernisation of the workplace. This includes the creation and adoption of policies that will provide better employment opportunities for women and mature age, Aboriginal and Torres Strait Islander people, returned soldiers, and other groups that have been excluded from opportunities in this industry. The Parties are also committed to supporting initiatives that will improve sustainable development and productivity across the industry. In accordance with provisions in this Agreement, the Parties will also seek broader industry wide actions to eliminate the existence of sham contracting.
- (b) The Parties may therefore seek to implement measures in the following categories:
 - (i) employment opportunities;
 - (ii) sustainability and productivity improvement; and
 - (iii) eradication of sham contracting

74.2 Employment Opportunities

- (a) initiatives to promote the employment of women, Indigenous, mature age or other groups that have been excluded from opportunities in this industry;
- (b) workers' health (including mental health) and wellbeing initiatives (such as health checks, suicide prevention, screening for dust diseases, drug and alcohol awareness and treatment);
- (c) programs to reduce bullying, sexual harassment or workplace discrimination;
- (d) initiatives to promote the take-up and completion of apprenticeships, such as mentoring programs; and
- (e) support the development of the establishment of registration of trades.

74.3 Sustainability and Productivity Improvement

- (a) waste-reduction, carbon pollution reduction and recycling initiatives;
- (b) investigate the possibility of introducing portable holiday leave schemes; and
- (c) initiatives to encourage fair, cooperative and productive workplace relations across the industry.

74.4 Eradication of Sham Contracting in the Building and Construction Industry

- (a) the Parties commit to participating and supporting industry-based initiatives for the eradication of sham contracting.

74.5 Industry Working Party

- (a) the Parties will support the establishment of an industry based working party of employers, unions and government with a view to the development and establishment of programs to achieve the objectives outlined above.

74.6 The above initiatives will comply with the relevant state and federal anti-discrimination legislation.

75 Signatories

Signed for and on behalf of **the Employer:**

Name (print): MATTHEW AYRES
Employer: INTRAFORM PTY LTD
Employer Position: DIRECTOR
Address: 16-18 BROUGHAM STREET, GEELONG, VIC 3220
Signature: 
Witness: LAUREN MCCULLOCH
Date: 30/10/2024.

Signed for and on behalf of the **CONSTRUCTION FORESTRY AND
MARITIME EMPLOYEES' UNION:**

Name ZACHARY SMITH
Position: EXECUTIVE OFFICER
Address: 540 Elizabeth Street, Melbourne, VIC 3000
Signature: 
Witness: 
Date: 31/10/2024

APPENDIX A – Classification

Employees will be classified according to the CW1 to CW7 classifications contained in Schedule A of the Award, including but not limited to the following examples:

LABOURERS

CW2 – 96%

Grade 2 – Concrete Finisher

PCW Operator Classification Structure

Classification	<i>Rollers</i>				<i>Compactors</i>				<i>Excavators</i>			
	Operating Wt		Oper.	Equiv. Cat.	Flywheel		Oper.	Equiv. Cat.	Operating Wt		Oper.	Equiv. Cat.
	Tonnes				Power kW				Tonnes			
	above	up to	Class.	Machines	above	up to	Class.	Machines	above	up to	Class.	Machines
(i) PCW1	0	5	PCW1	CS-323C								
PCW2	5	10	PCW2	431 TO 533								
Classification	<i>Backhoe Loader</i>				<i>Skid Stear</i>				<i>Wheel & Track Loaders</i>			
	Single Class.		Oper.	Equiv. Cat.	Operating Wt		Oper.	Equiv. Cat.	Net Flywheel		Oper.	Equiv. Cat.
	Tonnes				Power kW				Power kW			
	above	up to	Class.	Machines	above	up to	Class.	Machines	above	up to	Class.	Machines
PCW1												
PCW2												
Classification	<i>Crawler Tractors</i>				<i>Graders</i>				<i>Scrapers</i>			
	Flywheel		Oper.	Equiv. Cat.	Net Flywheel		Oper.	Equiv. Cat.	Flywheel PowerkW		Oper.	Equiv. Cat.
	Power kW				Power kW				(Tractor only on Twins)			
	above	up to	Class.	Machines	above	up to	Class.	Machines	above	up to	Class.	Machines
PCW1												
PCW2												
Classification	<i>Trucks</i>				<i>Mobile Cranes</i>							

CFMEU (Victorian Construction and General Division) Subcontractors Concrete Kerb,
Channel & Pavement Enterprise Agreement 2024-2027

	Maximum Payload tonnes		Oper. Class.	Equiv. Cat. Machines	Capacity		Oper. Class.	Equiv. Cat. Machines
	above	up to			above	up to		
	PCW1							
PCW2	0	12	PCW2	Small Rigid Trucks				

Note: Machine classes based on Caterpillar Performance Handbook

APPENDIX B – Wage Rates

This Appendix sets out wage rates payable under this Agreement.

The classifications in the Agreement correspond to the classifications in Schedule A of the Award.

Some occupations are specified in Schedule A of the Award but are not set out in this Appendix. An Employee working in an occupation set out in the Award but not appearing in the Agreement is paid at the lowest rate in this Appendix for the relevant CW/PCW classification. For example, a locksmith is within the CW3 classification in the Award. A locksmith under the Agreement is paid at the lowest rate for a classification within the CW3 band in the Agreement, that is, the rate payable to a Painter-Repaint.

SECTION 1
From 1st Pay Period beginning on/after 1 July 2024

The weekly pro rata annual leave loading will be calculated in accordance with the following formula:

$$\frac{(\text{Weekly rate} + \text{weekly travel}) \times 0.175}{13}$$

	Rate Per Hour \$	Rate Per Week \$	Weekly Pro-Rata Annual Leave \$	Weekly Pro-Rata A/L loading \$	RDO Accrual Per Day (0.8) \$
LABOURERS					
CW 2 - 96%.					
Grade 2 – Concrete Finisher	53.03	1909.08	146.85	29.37	42.42

SECTION 1 (Continued)
From 1st Pay Period beginning on/after 1 July 2024

The weekly pro rata annual leave loading will be calculated in accordance with the following formula:

$$\frac{(\text{Weekly rate} + \text{weekly travel}) \times 0.175}{13}$$

	Rate Per Hour \$	Rate Per Week \$	Weekly Pro-Rata Annual Leave \$	Weekly Pro-Rata A/L loading \$	RDO Accrual Per Day (0.8) \$
PLANT OPERATORS					
PCW1 - 92.4%					
New Entrant for plant only, Rollers up to 5 tonnes	49.42	1779.12	136.86	27.62	39.54
PCW2 - 96%					
Rollers 5 to 10 tonnes, Skid Steer & Backhoe/Loaders to 200kw, Construction Trucks up to 12 tonnes	51.32	1847.52	142.12	28.54	41.06

SECTION 2

From 1st Pay Period beginning on/after 1 February 2025

The weekly pro rata annual leave loading will be calculated in accordance with the following formula:

$$\frac{(Weekly\ rate + weekly\ travel) \times 0.175}{13}$$

	Rate Per Hour \$	Rate Per Week \$	Weekly Pro-Rata Annual Leave \$	Weekly Pro-Rata A/L loading \$	RDO Accrual Per Day (0.8) \$
LABOURERS					
CW 2 - 96%					
Grade 2 – Concrete Finisher	55.68	2004.48	154.19		44.54

SECTION 2 (Continued)

From 1st Pay Period beginning on/after 1 February 2025

The weekly pro rata annual leave loading will be calculated in accordance with the following formula:

$$\frac{(Weekly\ rate + weekly\ travel) \times 0.175}{13}$$

	Rate Per Hour \$	Rate Per Week \$	Weekly Pro-Rata Annual Leave \$	Weekly Pro-Rata A/L loading \$	RDO Accrual Per Day (0.8) \$
PLANT OPERATORS					
PCW1 - 92.4%					
New Entrant for plant only, Rollers up to 5 tonnes	51.89	1868.04	143.70		41.51
PCW2 - 96%					
Rollers 5 to 10 tonnes, Skid Steer & Backhoe/Loaders to 200kw, Construction Trucks up to 12 tonnes	53.89	1940.04	149.23		43.11

SECTION 3

From 1st Pay Period beginning on/after 1 February 2026

The weekly pro rata annual leave loading will be calculated in accordance with the following formula:

$$\frac{(Weekly\ rate + weekly\ travel) \times 0.175}{13}$$

	Rate Per Hour \$	Rate Per Week \$	Weekly Pro-Rata Annual Leave \$	Weekly Pro-Rata A/L loading \$	RDO Accrual Per Day (0.8) \$
LABOURERS					
CW 2 - 96%					
Grade 2 – Concrete Finisher	58.46	2104.56	161.89		46.77

SECTION 3 (Continued)

From 1st Pay Period beginning on/after 1 February 2026

The weekly pro rata annual leave loading will be calculated in accordance with the following formula:

$$\frac{(Weekly\ rate + weekly\ travel) \times 0.175}{13}$$

	Rate Per Hour \$	Rate Per Week \$	Weekly Pro-Rata Annual Leave \$	Weekly Pro-Rata A/L loading \$	RDO Accrual Per Day (0.8) \$
PLANT OPERATORS					
PCW1 - 92.4%					
New Entrant for plant only, Rollers up to 5 tonnes	54.48	1961.28	150.87		43.58
PCW2 - 96%					
Rollers 5 to 10 tonnes, Skid Steer & Backhoe/Loaders to 200kw, Construction Trucks up to 12 tonnes	56.58	2036.88	156.68		45.26

SECTION 4

From 1st Pay Period beginning on/after 1 February 2027

The weekly pro rata annual leave loading will be calculated in accordance with the following formula:

$$\frac{(Weekly\ rate + weekly\ travel) \times 0.175}{13}$$

	Rate Per Hour \$	Rate Per Week \$	Weekly Pro-Rata Annual Leave \$	Weekly Pro-Rata A/L loading \$	RDO Accrual Per Day (0.8) \$
LABOURERS					
CW 2 - 96%					
Grade 2 – Concrete Finisher	61.38	2209.68	169.98		49.10

SECTION 4 (Continued)

From 1st Pay Period beginning on/after 1 February 2027

The weekly pro rata annual leave loading will be calculated in accordance with the following formula:

$$\frac{(Weekly\ rate + weekly\ travel) \times 0.175}{13}$$

	Rate Per Hour \$	Rate Per Week \$	Weekly Pro-Rata Annual Leave \$	Weekly Pro-Rata A/L loading \$	RDO Accrual Per Day (0.8) \$
PLANT OPERATORS					
PCW1 - 92.4%					
New Entrant for plant only, Rollers up to 5 tonnes	57.20	2059.20	158.40		45.76
PCW2 - 96%					
Rollers 5 to 10 tonnes, Skid Steer & Backhoe/Loaders to 200kw, Construction Trucks up to 12 tonnes	59.41	2138.76	164.52		47.53

APPENDIX C – Site Allowance Procedure

1. Site Allowance shall be determined in accordance with this Appendix.
2. It is agreed by the Parties that all new Projects with a Project Value (as defined in **clause 2** of the Agreement) of \$5.7 million and above will be covered by the Site Allowance rates contained in this Appendix.
3. It is agreed by the Parties that the Site Allowance will not be claimed on any Project where the Project Value is below \$5.7 million. On Projects which do not attract the Site Allowance, Employees are entitled to be paid all relevant Special Rates or Disability Payments under the Award.
4. The Site Allowance shall be paid at the appropriate rate for all paid ordinary and overtime hours. Site Allowances are not payable during a period of paid leave. The Site Allowance compensates Employees for all special factors and/or disabilities on a project and is paid in lieu of the following Special Rates in the Award – Confined Space, Wet Work, Dirty Work, Second-hand Timber and Fumes.
5. Award Special Rates and Disability Payments (other than those outlined above) shall continue to apply in accordance with the Award.
6. The payment of Insulation Allowance shall only be paid to individual Employees who are affected (as defined in the Award) by the use of such materials.
7. The Site Allowance and other Award Special Rates form part of Ordinary Time Earnings as defined in **clause 2** of this Agreement.

Determining Site Allowance

8. Where the Union on behalf of Employees, requests an Employer to consider a claim for payment of a Site Allowance, such Site Allowance shall be determined by reference to:
 - 8.1. The terms of this Appendix; or
 - 8.2. By determination of the Victorian Building Industry Disputes Panel in accordance with this Appendix.

Site Allowance rates

9. The appropriate Site Allowance shall be based on the Total Project Value, as defined in **clause 2** of this Agreement
 - 9.1. Site Allowance rates for the City of Melbourne.

The following rates apply to sites in the City of Melbourne as defined by **clause 18** of this Appendix:

New Projects

Projects \$5.7 million to \$289.1 million	\$5.00 per hour
Projects with values in excess of \$289.1 million	See applicable rates at 9.2 below

Renovations, Restorations and/or Refurbishments

Projects \$5.7 million to \$289.1 million	\$4.35 per hour
Projects with values in excess of \$289.1 million	See applicable rates at 9.2 below

Where Projects are a combination of new work and renovation, restoration and/or refurbishment work, the New Projects allowance will be paid where the value of that new work is more than 33% of the Total Project Value.

9.2. Site allowance rates for Victoria

Above \$5.7 m but less than \$34.7 m	\$2.85 per hour
\$34.7 m but less than \$58 m	\$3.50 per hour
\$58 m but less than \$115.6 m	\$4.00 per hour
\$115.6 m but less than \$289.1 m	\$4.60 per hour
\$289.1 m but less than \$462.5 m	\$5.25 per hour
\$462.5 m but less than \$1156.4 m	\$5.75 per hour
\$1156.4 but less than \$2312.7 m	\$6.90 per hour
\$2312.7 but less than \$3469.2 m	\$7.50 per hour
\$3469.2 but less than \$4625.4 m	\$8.10 per hour

Any Site Allowance which is in place at the time of this Agreement commencing, and which provides a higher site allowance than that set out in **clause 9** of this Appendix, will continue to apply until such time as that rate rises above the applicable rates in **clause 9** of this Appendix, at which point the higher rate under this Appendix will apply.

10. Site Allowance rates and Project Values during the life of this Agreement will be adjusted annually in accordance with CPI (All Groups, Melbourne) movements measured in the twelve month period ending the previous June quarter effective as of the 1 October from 2024 onwards.
11. The Site Allowance shall be adjusted to the nearest 5 cents and the Project Value to the nearest \$100,000.
12. Project Specific Site Allowance Rates as at 1 October 2023

- 12.1. The Site Allowance applicable to the West Gate Tunnel Project shall be \$10.70 per hour.
- 12.2. The Site Allowance applicable to the Metro Tunnel Project shall be \$11.10 per hour.
- 12.3. The above rates will be adjusted as per **clause 10** of this appendix.
- 12.4. The Site Allowance applicable to the North East Link Project shall be:
 - (a) As at 1 March 2024 - \$10.75 per hour;
 - (b) As at 1 March 2026 - \$11.15 per hour;
 - (c) As at 1 March 2027 - \$11.55 per hour.

Determination by the Victorian Building Industry Disputes Panel

- 13. Where the Parties fail to reach Agreement on the Site Allowance rate to apply to a particular site or Project, then such disagreement shall be referred to the Panel for determination.
- 14. In determining the Site Allowance rate, the Panel shall not deviate from the methods set out in this Appendix, unless there are special and/or exceptional circumstances.
 - 14.1. Special and/or exceptional circumstances may include work on Projects where disabilities that are not accounted for in this Appendix exist. This includes, but is not limited to:
 - Projects where construction/maintenance work is predominantly being performed by contract metal trades;
 - Infrastructure Projects with more than a four-billion-dollar Project Value.
 - 14.2. Where the procedures prescribed by this clause are being followed, work shall continue normally. In the event that Employees take industrial action whilst the Panel is determining a Site Allowance under this Appendix, the date of commencement for that Site Allowance shall not be before the date on which the Employees cease industrial action.
- 15. Any Site Allowance that is determined in accordance with this Appendix is final and binding on the Parties. The Parties agree to comply, and give effect to a determination by the Panel under this Appendix. A failure to do so is a breach of the Agreement.

Shopping Centre and Airport Projects

- 16. All new construction and extension/refurbishment work at shopping centres, airports, retail strip shops and standalone retail facilities, having a Project Value in excess of \$5.7 million will attract the then current City of Melbourne Site Allowance.

17. Where the Project is of a mixed purpose, City of Melbourne Site Allowance Rate will apply only where the retail component is at least \$5.7 million and occupies at least 51% of the area of the Project.

Definition of City of Melbourne

18. For the purposes of determining Site Allowance in accordance with this Agreement, the boundaries of the “City of Melbourne” are defined as follows:
- 18.1. Commencing at the point where Citylink (at Tullamarine Freeway) intersects Racecourse Road, proceed east along Racecourse Road, Elliott Avenue, Macarthur Road, Cemetery Road West, Cemetery Road East and Princes Street to Nicholson Street. Then South on Nicholson Street to Victoria Parade. In Victoria Parade proceed east to Punt Road, then proceed south along Punt Road to St Kilda Junction.
- 18.2. From St Kilda Junction proceed along Fitzroy Street to Beaconsfield Parade, and then north-west along Beaconsfield Parade, Beach Street and The Boulevard and following the waterline to Lorimer Street, and then east along Lorimer Street as far as Citylink (Western Link). Follow Citylink north to Racecourse Road to complete the boundary.
- 18.3. The City of Melbourne zone will also include the area bounded by Nicholson Street, Victoria Parade, Hoddle Street and Alexandra Parade.
- 18.4. Where one boundary of a Project fronts at least one of the above streets, then such Project is deemed to be within the City of Melbourne.

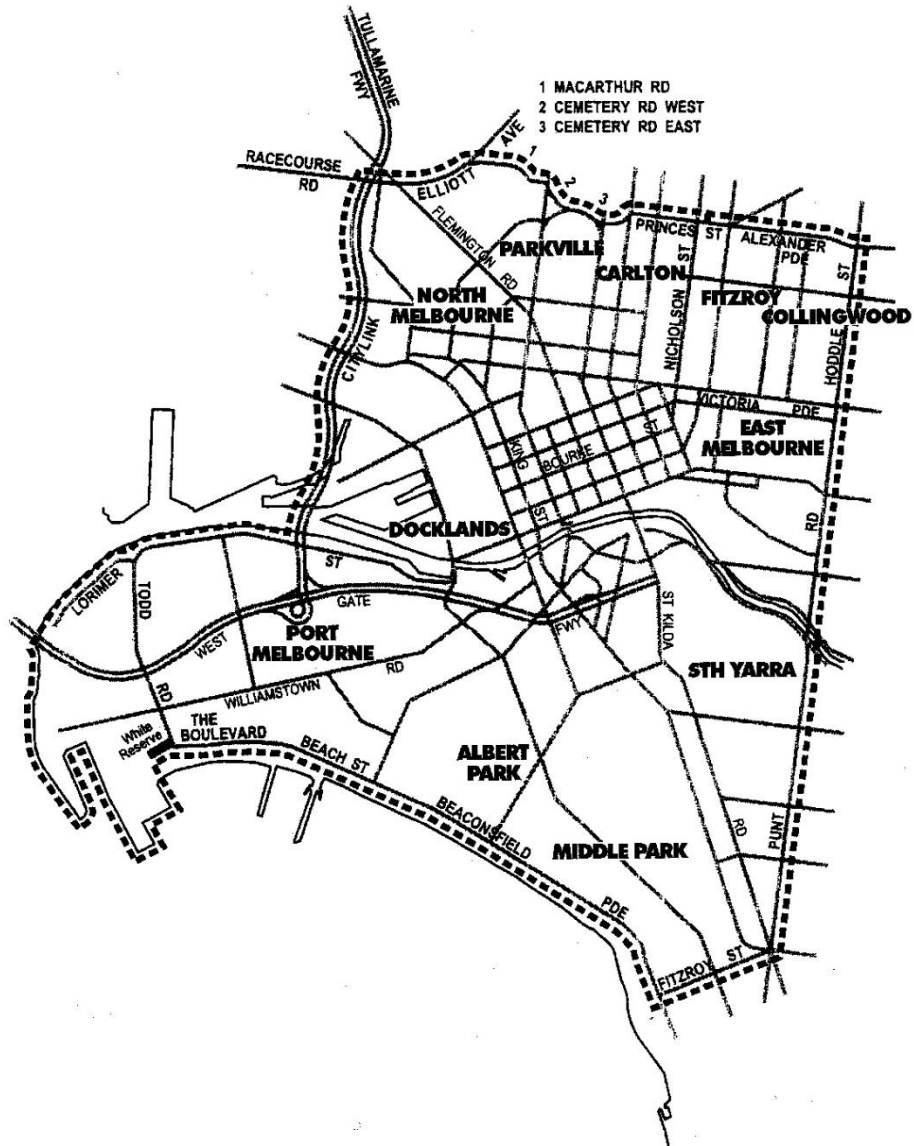

APPENDIX D – RDO Calendars

WORKING DAY CALENDAR 2024

JANUARY						
Sun	Mon	Tue	Wed	Thu	Fri	Sat
	1 PH	2 AL	3 AL	4 AL	5 AL	6
7	8 AL	9 RDO	10	11	12	13
14	15	16	17	18	19	20
21	22	23	24	25	26 PH	27
28	29 RDO	30	31			

FEBRUARY						
Sun	Mon	Tue	Wed	Thu	Fri	Sat
				1	2	3
4	5	6	7	8	9	10
11	12 RDO	13	14	15	16	17
18	19	20	21	22	23	24
25	26 RDO	27	28	29	30	31

MARCH						
Sun	Mon	Tue	Wed	Thu	Fri	Sat
31					1	2
3	4	5	6	7	8	9
10	11 PH	12 RDO	13	14	15	16
17	18	19	20	21	22	23
24	25	26	27	28 PH	29	30

APRIL						
Sun	Mon	Tue	Wed	Thu	Fri	Sat
	1 PH	2 RDO	3 RDO	4	5	6
7	8	9	10	11	12	13
14	15	16	17	18	19	20
21	22	23	24	25	26 PH	27
28	29	30				

MAY						
Sun	Mon	Tue	Wed	Thu	Fri	Sat
			1	2	3	4
5	6 RDO	7	8	9	10	11
12	13	14	15	16	17	18
19	20 RDO	21	22	23	24	25
26	27	28	29	30	31	

JUNE						
Sun	Mon	Tue	Wed	Thu	Fri	Sat
30						1
2	3	4	5	6	7	8
9	10 PH	11 RDO	12	13	14	15
16	17	18	19	20	21	22
23	24 RDO	25	26	27	28	29

JULY						
Sun	Mon	Tue	Wed	Thu	Fri	Sat
	1	2	3	4	5	6
7	8 RDO	9	10	11	12	13
14	15	16	17	18	19	20
21	22 RDO	23	24	25	26	27
28	29	30	31			

AUGUST						
Sun	Mon	Tue	Wed	Thu	Fri	Sat
				1	2	3
4	5 RDO	6	7	8	9	10
11	12	13	14	15	16	17
18	19 RDO	20	21	22	23	24
25	26	27	28	29	30	31

SEPTEMBER						
Sun	Mon	Tue	Wed	Thu	Fri	Sat
1	2 RDO	3	4	5	6	7
8	9	10	11	12	13	14
15	16 RDO	17	18	19	20	21
22	23	24	25	26	27 PH	28
29	30 RDO					

OCTOBER						
Sun	Mon	Tue	Wed	Thu	Fri	Sat
		1	2	3	4	5
6	7 RDO	8	9	10	11	12
13	14	15	16	17	18	19
20	21 RDO	22	23	24	25	26
27	28	29	30	31		

NOVEMBER						
Sun	Mon	Tue	Wed	Thu	Fri	Sat
				1	2	3
4	5 RDO	6 PH	7 RDO	8	9	10
11	12	13	14	15	16	17
18	19 RDO	20	21	22	23	24
25	26	27	28	29	30	31

DECEMBER						
Sun	Mon	Tue	Wed	Thu	Fri	Sat
1	2 PH	3	4	5	6	7
8	9	10	11	12	13	14
15	16	17	18	19	20	21
22	23 RDO	24 RDO	25 PH	26 PH	27 AL	28
29	30 AL	31 AL				

PH = Public Holiday
RDOs = Scheduled Rostered Day Off
AL = Annual Leave
FD = Flotric Day

Dated: 03/June/2020

CFMEU (Victorian Construction and General Division) Subcontractors Concrete Kerb,
Channel & Pavement Enterprise Agreement 2024-2027

WORKING DAY CALENDAR 2025

JANUARY						
Sun	Mon	Tue	Wed	Thu	Fri	Sat
			1 PH	2 AL	3 AL	4
5	6 AL	7 AL	8 AL	9 AL	10 AL	11
12	13 RDO	14	15	16	17	18
19	20	21	22	23	24	25
26	27 PH	28 RDO	29	30	31	

FEBRUARY						
Sun	Mon	Tue	Wed	Thu	Fri	Sat
						1 15
2	3	4	5	6	7	8
9	10 RDO	11	12	13	14	15
16	17	18	19	20	21	22
23	24 RDO	25	26	27	28	

MARCH						
Sun	Mon	Tue	Wed	Thu	Fri	Sat
30	31 RDO					1 37
2	3	4	5	6	7	8
9	10 PH	11 RDO	12	13	14	15
16	17	18	19	20	21	22
23	24	25	26	27	28	29

APRIL						
Sun	Mon	Tue	Wed	Thu	Fri	Sat
		1	2	3	4	5
		59	60	61	62	63
6	7	8	9	10	11	12
	14	15	16	17	18 PH	19
20	21 PH	22 RDO	23 RDO	24 AL	25 PH	26
27	28	29	30			

MAY						
Sun	Mon	Tue	Wed	Thu	Fri	Sat
				1	2	3
				77	78	79
4	5 RDO	6	7	8	9	10
11	12	13	14	15	16	17
18	19 RDO	20	21	22	23	24
25	26	27	28	29	30	31

JUNE						
Sun	Mon	Tue	Wed	Thu	Fri	Sat
1	2	3	4	5	6	7
	102	103	104	105	106	107
8	9 PH	10 RDO	11	12	13	14
15	16	17	18	19	20	21
22	23 RDO	24	25	26	27	28
29	30					

JULY						
Sun	Mon	Tue	Wed	Thu	Fri	Sat
		1	2	3	4	5
		123	124	125	126	127
6	7 RDO	8	9	10	11	12
13	14	15	16	17	18	19
20	21 RDO	22	23	24	25	26
27	28	29	30	31		

AUGUST						
Sun	Mon	Tue	Wed	Thu	Fri	Sat
31					1	2
				148	149	
3	4 RDO	5	6	7	8	9
10	11	12	13	14	15	16
17	18 RDO	19	20	21	22	23
24	25	26	27	28	29	30

SEPTEMBER						
Sun	Mon	Tue	Wed	Thu	Fri	Sat
	1 RDO	2	3	4	5	6
	172	173	174	175	176	
7	8	9	10	11	12	13
14	15 RDO	16	17	18	19	20
21	22	23	24	25	26 PH	27
28	29 RDO	30				

OCTOBER						
Sun	Mon	Tue	Wed	Thu	Fri	Sat
			1	2	3	4
			193	194	195	196
5	6	7	8	9	10	11
12	13 RDO	14	15	16	17	18
19	20	21	22	23	24	25
26	27 RDO	28	29	30	31	

NOVEMBER						
Sun	Mon	Tue	Wed	Thu	Fri	Sat
30						1
2	3 RDO	4 PH	5 RDO	6	7	8
9	10	11	12	13	14	15
16	17 RDO	18	19	20	21	22
23	24	25	26	27	28	29

DECEMBER						
Sun	Mon	Tue	Wed	Thu	Fri	Sat
	1 RDO	2	3	4	5	6
	238	239	240	241	242	
7	8	9	10	11	12	13
14	15	16	17	18	19	20
21	22 RDO	23 RDO	24 AL	25 PH	26 PH	27
28	29 AL	30 AL	31 AL			

PH = Public Holiday
RDOs = Scheduled Rostered Day Off
AL = Annual Leave
PD = Picnic Day

Dated: 03/June/2020

WORKING DAY CALENDAR 2026

JANUARY						
Sun	Mon	Tue	Wed	Thu	Fri	Sat
				1 PH	2 AL	3
4	5 AL	6 AL	7	8	9 AL	10
11	12 RDO	13	14	15	16	17
18	19	20	21	22	23	24
	25 PH	26	27 RDO	28	29	30
		12	13	14	15	

FEBRUARY						
Sun	Mon	Tue	Wed	Thu	Fri	Sat
1	2	3	4	5	6	7
	16	17	18	19	20	21
8	9 RDO	10	11	12	13	14
15	16	17	18	19	20	21
	27	28	29	30	31	32
22	23 RDO	24	25	26	27	28
		33	34	35	36	37

MARCH						
Sun	Mon	Tue	Wed	Thu	Fri	Sat
1	2	3	4	5	6	7
	38	39	40	41	42	
8	9 PH	10 RDO	11	12	13	14
15	16	17	18	19	20	21
	47	48	49	50	51	52
22	23 RDO	24	25	26	27	28
29	30	31				
	58	59				

APRIL						
Sun	Mon	Tue	Wed	Thu	Fri	Sat
			1	2	3 PH	4
5	6 PH	7 RDO	8	9	10	11
	13	14	15	16	17	18
12	19	20	21	22	23	24
	27	28	29	30		
25	26 PH	27 RDO	28	29	30	
		76	77			

MAY						
Sun	Mon	Tue	Wed	Thu	Fri	Sat
31					1	2
					78	79
3	4	5	6	7	8	9
	80	81	82	83	84	85
10	11 RDO	12	13	14	15	16
	86	87	88	89	90	
17	18	19	20	21	22	23
	91	92	93	94	95	96
24	25 RDO	26	27	28	29	30
		97	98	99	100	101

JUNE						
Sun	Mon	Tue	Wed	Thu	Fri	Sat
	1	2	3	4	5	6
	102	103	104	105	106	
7	8 PH	9 RDO	10	11	12	13
	107	108	109	110		
14	15	16	17	18	19	20
	111	112	113	114	115	116
21	22 RDO	23	24	25	26	27
	117	118	119	120	121	
28	29	30				
	122	123				

JULY						
Sun	Mon	Tue	Wed	Thu	Fri	Sat
			1	2	3	4
			124	125	126	127
5	6 RDO	7	8	9	10	11
	128	129	130	131	132	
12	13	14	15	16	17	18
	133	134	135	136	137	138
19	20	21	22	23	24	25
	139	140	141	142	143	
26	27	28	29	30	31	
	144	145	146	147	148	

AUGUST						
Sun	Mon	Tue	Wed	Thu	Fri	Sat
30	31 RDO					1
						148
2	3 RDO	4	5	6	7	8
	150	151	152	153	154	
9	10	11	12	13	14	15
	155	156	157	158	159	160
16	17 RDO	18	19	20	21	22
	161	162	163	164	165	
23	24	25	26	27	28	29
	166	167	168	169	170	171

SEPTEMBER						
Sun	Mon	Tue	Wed	Thu	Fri	Sat
		1	2	3	4	5
		172	173	174	175	176
6	7	8	9	10	11	12
	177	178	179	180	181	182
13	14 RDO	15	16	17	18	19
	183	184	185	186	187	
20	21	22	23	24	25 PH	26
	188	189	190	191		
27	28 RDO	29	30			
	192	193				

OCTOBER						
Sun	Mon	Tue	Wed	Thu	Fri	Sat
				1	2	3
				194	195	196
4	5	6	7	8	9	10
	197	198	199	200	201	202
11	12 RDO	13	14	15	16	17
	203	204	205	206	207	
18	19	20	21	22	23	24
	208	209	210	211	212	213
25	26 RDO	27	28	29	30	31
		214	215	216	217	

NOVEMBER						
Sun	Mon	Tue	Wed	Thu	Fri	Sat
1	2 RDO	3 PH	4 RDO	5	6	7
	221	222	223	224	225	226
8	9	10	11	12	13	14
	227	228	229	230	231	
15	16	17	18	19	20	21
	232	233	234	235	236	237
22	23	24	25	26	27	28
	238					
29	30					
	238					

DECEMBER						
Sun	Mon	Tue	Wed	Thu	Fri	Sat
		1	2	3	4	5
		239	240	241	242	243
6	7 RDO	8	9	10	11	12
	244	245	246	247	248	
13	14	15	16	17	18	19
	249	250	251	252	253	254
20	21	22	23 RDO	24 AL	25 PH	26
	255	256				
27	28 PH	29 AL	30 AL	31 AL		

PH = Public Holiday
RDOs = Scheduled Rostered Day Off
AL = Annual Leave
PD = Plonk Day

Updated 03/Jun/2020

WORKING DAY CALENDAR 2027

JANUARY						
Sun	Mon	Tue	Wed	Thu	Fri	Sat
					1 PH	2
3	4 AL	5 AL	6 AL	7 AL	8 AL	9
10	11 RDO	12 RDO	13	14	15	16
17	18 5	19 6	20 7	21 8	22 9	23
24	25 RDO	26 PH	27	28	29	30

FEBRUARY						
Sun	Mon	Tue	Wed	Thu	Fri	Sat
	1 14	2 15	3 16	4 17	5 18	6 19
7	8 RDO	9	10	11	12	13
14	15 25	16 26	17 27	18 28	19 29	20 30
21	22 RDO	23 31	24	25	26	27
28						

MARCH						
Sun	Mon	Tue	Wed	Thu	Fri	Sat
	1 36	2 37	3 38	4 39	5 40	6
7	8 PH	9 RDO	10	11	12	13
14	15 45	16 46	17 47	18 48	19 49	20 50
21	22 51	23 52	24 53	25 54	26 PH	27 PH
28	29 PH	30 RDO	31			

APRIL						
Sun	Mon	Tue	Wed	Thu	Fri	Sat
				1 55	2 56	3 57
4	5 58	6 59	7 60	8 61	9 62	10 63
11	12 RDO	13	14	15	16	17
18	19 69	20 70	21 71	22 72	23 73	24
25	26 PH	27 RDO	28	29	30	

MAY						
Sun	Mon	Tue	Wed	Thu	Fri	Sat
30	31 100					1 77
2	3 78	4 79	5 80	6 81	7 82	8 83
9	10 RDO	11	12	13	14	15
16	17 89	18 90	19 91	20 92	21 93	22 94
23	24 RDO	25 95	26 96	27 97	28 98	29 99

JUNE						
Sun	Mon	Tue	Wed	Thu	Fri	Sat
		1 101	2 102	3 103	4 104	5 105
6	7 106	8 107	9 108	10 109	11 110	12
13	14 PH	15 RDO	16	17	18	19
20	21 115	22 116	23 117	24 118	25 119	26 120
27	28 RDO	29 121	30 122			

JULY						
Sun	Mon	Tue	Wed	Thu	Fri	Sat
				1 123	2 124	3 125
4	5 126	6 127	7 128	8 129	9 130	10 131
11	12 RDO	13 132	14 133	15 134	16 135	17 136
18	19 137	20 138	21 139	22 140	23 141	24 142
25	26 RDO	27 143	28 144	29 145	30 146	31 147

AUGUST						
Sun	Mon	Tue	Wed	Thu	Fri	Sat
1	2 148	3 149	4 150	5 151	6 152	7 153
8	9 RDO	10 154	11 155	12 156	13 157	14 158
15	16 159	17 160	18 161	19 162	20 163	21 164
22	23 RDO	24 165	25 166	26 167	27 168	28 169
29	30 170	31 171				

SEPTEMBER						
Sun	Mon	Tue	Wed	Thu	Fri	Sat
			1 172	2 173	3 174	4 175
5	6 RDO	7 176	8 177	9 178	10 179	11 180
12	13 181	14 182	15 183	16 184	17 185	18 186
19	20 187	21 188	22 189	23 190	24 PH	25
26	27 RDO	28 191	29 192	30 193		

OCTOBER						
Sun	Mon	Tue	Wed	Thu	Fri	Sat
31					1 194	2 195
3	4 RDO	5 196	6 197	7 198	8 199	9 200
10	11 201	12 202	13 203	14 204	15 205	16 206
17	18 RDO	19 207	20 208	21 209	22 210	23 211
24	25 212	26 213	27 214	28 215	29 216	30

NOVEMBER						
Sun	Mon	Tue	Wed	Thu	Fri	Sat
	1 RDO	2 PH	3 RDO	4 217	5 218	6 219
7	8 220	9 221	10 222	11 223	12 224	13 225
14	15 RDO	16 226	17 227	18 228	19 229	20 230
21	22 231	23 232	24 233	25 234	26 235	27 236
28	29 237	30 238				

DECEMBER						
Sun	Mon	Tue	Wed	Thu	Fri	Sat
			1 239	2 240	3 241	4 242
5	6 PH	7 243	8 244	9 245	10 246	11 247
12	13 248	14 249	15 250	16 251	17 252	18 253
19	20 254	21 255	22 256	23 257	24 RDO	25 PH
26	27 PH	28 PH	29 AL	30 AL	31 AL	

PH = Public Holiday
RDOs = Scheduled Rostered Day Off
AL = Annual Leave
PD = Public Day

WORKING DAY CALENDAR 2028

JANUARY						
Sun	Mon	Tue	Wed	Thu	Fri	Sat
30	31					1 PH
2	3 PH	4 AL	5 AL	6 AL	7 AL	8
9	10 RDO	11 RDO	12	13	14	15
16	17	18	19	20	21	22
23	24	25	26 PH	27 RDO	28 RDO	29

FEBRUARY						
Sun	Mon	Tue	Wed	Thu	Fri	Sat
		14	15	16	17	18
6	7 RDO	8	9	10	11	12
13	14	15	16	17	18	19
20	21 RDO	22	23	24	25	26
27	28	29				

MARCH						
Sun	Mon	Tue	Wed	Thu	Fri	Sat
			1	2	3	4
5	6	7	8	9	10	11
12	13 PH	14 RDO	15	16	17	18
19	20	21	22	23	24	25
26	27 RDO	28	29	30	31	

APRIL						
Sun	Mon	Tue	Wed	Thu	Fri	Sat
30						1 60
2	3	4	5	6	7	8
9	10	11	12	13	14 PH	15 PH
16 PH	17 PH	18 AL	19 AL	20 RDO	21 RDO	22
23	24 RDO	25 PH	26	27	28	29

MAY						
Sun	Mon	Tue	Wed	Thu	Fri	Sat
	1	2	3	4	5	6
7	8	9	10	11	12	13
14	15 RDO	16	17	18	19	20
21	22	23	24	25	26	27
28	29 RDO	30	31			

JUNE						
Sun	Mon	Tue	Wed	Thu	Fri	Sat
				1	2	3
4	5	6	7	8	9	10
11	12 PH	13 RDO	14	15	16	17
18	19	20	21	22	23	24
25	26 RDO	27	28	29	30	

JULY						
Sun	Mon	Tue	Wed	Thu	Fri	Sat
30	31					1 122
2	3	4	5	6	7	8
9	10 RDO	11	12	13	14	15
16	17	18	19	20	21	22
23	24 RDO	25	26	27	28	29

AUGUST						
Sun	Mon	Tue	Wed	Thu	Fri	Sat
		1	2	3	4	5
6	7 RDO	8	9	10	11	12
13	14	15	16	17	18	19
20	21 RDO	22	23	24	25	26
27	28	29	30	31		

SEPTEMBER						
Sun	Mon	Tue	Wed	Thu	Fri	Sat
					1	2
3	4 RDO	5	6	7	8	9
10	11	12	13	14	15	16
17	18 RDO	19	20	21	22	23
24	25	26	27	28	29 PH	30

OCTOBER						
Sun	Mon	Tue	Wed	Thu	Fri	Sat
1	2 RDO	3	4	5	6	7
8	9	10	11	12	13	14
15	16 RDO	17	18	19	20	21
22	23	24	25	26	27	28
29	30	31				

NOVEMBER						
Sun	Mon	Tue	Wed	Thu	Fri	Sat
			1	2	3	4
5	6 RDO	7 PH	8 RDO	9	10	11
12	13	14	15	16	17	18
19	20 RDO	21	22	23	24	25
26	27	28	29	30		

DECEMBER						
Sun	Mon	Tue	Wed	Thu	Fri	Sat
31					1	2
3	4 PH	5	6	7	8	9
10	11	12	13	14	15	16
17	18	19	20	21	22	23
24	25 PH	26 PH	27 AL	28 AL	29 AL	30

PH = Public Holiday
RDOs = Scheduled Rostered Day Off
AL = Annual Leave
PD = Public Day

WORKING DAY CALENDAR 2029

JANUARY						
Sun	Mon	Tue	Wed	Thu	Fri	Sat
	1 PH	2 AL	3 AL	4 AL	5 AL	6
7	8 RDO	9 RDO	10	11	12	13
14	15 5	16 6	17 7	18 8	19 9	20 10
21	22 11	23 12	24 13	25 14	26 PH	27
28	29 RDO	30 15	31 16			

FEBRUARY						
Sun	Mon	Tue	Wed	Thu	Fri	Sat
				1 17	2 18	3 19
4	5 20	6 21	7 22	8 23	9 24	10 25
11	12 RDO	13 26	14 27	15 28	16 29	17 30
18	19 31	20 32	21 33	22 34	23 35	24 36
25	26 RDP	27 37	28 38			

MARCH						
Sun	Mon	Tue	Wed	Thu	Fri	Sat
				1 39	2 40	3 41
4	5 42	6 43	7 44	8 45	9 46	10
11	12 PH	13 RDO	14 47	15 48	16 49	17 50
18	19 51	20 52	21 53	22 54	23 55	24 56
25	26 57	27 58	28 59	29 60	30 PH	31 PH

APRIL						
Sun	Mon	Tue	Wed	Thu	Fri	Sat
1 PH	2 PH	3 RDO	4 RDO	5 61	6 62	7 63
8	9 64	10 65	11 66	12 67	13 68	14 69
15	16 70	17 71	18 72	19 73	20 74	21 75
22	23 76	24 77	25 PH	26 RDO	27 RDO	28
29	30 78					

MAY						
Sun	Mon	Tue	Wed	Thu	Fri	Sat
		1 79	2 80	3 81	4 82	5 83
6	7 84	8 85	9 86	10 87	11 88	12 89
13	14 RDO	15 90	16 91	17 92	18 93	19 94
20	21 95	22 96	23 97	24 98	25 99	26 100
27	28 RDO	29 101	30 102	31 103		

JUNE						
Sun	Mon	Tue	Wed	Thu	Fri	Sat
					1 104	2 105
3	4 106	5 107	6 108	7 109	8 110	9
10	11 PH	12 RDO	13 111	14 112	15 113	16 114
17	18 115	19 116	20 117	21 118	22 119	23 120
24	25 RDO	26 121	27 122	28 123	29 124	30 125

JULY						
Sun	Mon	Tue	Wed	Thu	Fri	Sat
1	2 126	3 127	4 128	5 129	6 130	7 131
8	9 RDO	10 132	11 133	12 134	13 135	14 136
15	16 137	17 138	18 139	19 140	20 141	21 142
22	23 RDO	24 143	25 144	26 145	27 146	28 147
29	30 148	31 149				

AUGUST						
Sun	Mon	Tue	Wed	Thu	Fri	Sat
			1 150	2 151	3 152	4 153
5	6 RDO	7 154	8 155	9 156	10 157	11 158
12	13 159	14 160	15 161	16 162	17 163	18 164
19	20 RDO	21 165	22 166	23 167	24 168	25 169
26	27 170	28 171	29 172	30 173	31 174	

SEPTEMBER						
Sun	Mon	Tue	Wed	Thu	Fri	Sat
30						1 175
2	3 RDO	4 176	5 177	6 178	7 179	8 180
9	10 181	11 182	12 183	13 184	14 185	15 186
16	17 RDO	18 187	19 188	20 189	21 190	22 191
23	24 192	25 193	26 194	27 195	28 PH	29

OCTOBER						
Sun	Mon	Tue	Wed	Thu	Fri	Sat
	1 RDO	2 196	3 197	4 198	5 199	6 200
7	8 201	9 202	10 203	11 204	12 205	13 206
14	15 RDO	16 207	17 208	18 209	19 210	20 211
21	22 212	23 213	24 214	25 215	26 216	27 217
28	29 218	30 219	31 220			

NOVEMBER						
Sun	Mon	Tue	Wed	Thu	Fri	Sat
				1 221	2 222	3
4	5 RDO	6 PH	7 RDO	8 223	9 224	10 225
11	12 226	13 227	14 228	15 229	16 230	17 231
18	19 RDO	20 232	21 233	22 234	23 235	24 236
25	26 237	27 238	28 239	29 240	30 241	

DECEMBER						
Sun	Mon	Tue	Wed	Thu	Fri	Sat
30	31 AL					1 242
2	3 PH	4 243	5 244	6 245	7 246	8 247
9	10 248	11 249	12 250	13 251	14 252	15 253
16	17 254	18 255	19 256	20 257	21 258	22
23	24 RDO	25 PH	26 PH	27 AL	28 AL	29

2030

1 Jan - PH 5 Jan - WE
2 Jan - AL 6 Jan - WE
3 Jan - AL 7 Jan - RDO
4 Jan - AL 8 Jan - RDO

PH = Public Holiday
RDOs = Scheduled Rostered Day Off
AL = Annual Leave
PH = Public Day

APPENDIX E – Training Leave for Workplace Representatives

Part A – Industrial Relations Training Leave

The Parties acknowledge that for workplace representatives to effectively undertake their duties they should have the appropriate level of training. The Employer recognises a workplace representative who is well trained in matters including the rights and obligations under the various industrial instruments that operate at the workplace and the rights and responsibilities under the relevant legislation will assist in minimising industrial disputes and further the objective of having a harmonious workplace. To that end the following leave provisions apply.

- (a) Subject to all qualifications in this clause, an employee appointed or elected as an accredited Union Delegate/Employee representative shall, upon application in writing to the Employer, be granted up to 5 days leave with pay each calendar year non-cumulative to attend courses approved by the Employer.
- i. Such courses shall be designed and structured with the objective of promoting good industrial relations within the Employer.
- ii. Consultation may take place between the Parties in the furtherance of this objective.
- (b) For the purposes of this clause an “*accredited Union Delegate/Employee representative*” shall mean an employee recognised by the Employer in accordance with **clause 49** of this Agreement.
- (c) The following scale shall apply:

No. of employees covered by this Agreement	Maximum No. of Workplace Representatives eligible to attend per year	Maximum No. of days permitted per year
Up to 15	1	5
16 – 30	2	10
31 – 50	3	15
51 – 100	4	20
101 and over	5	25

- (d) The application for leave shall be given to the Employer at least 4 weeks in advance of the date of commencement of the course. The application for leave shall contain the following details:
- i. The name of the employee seeking the leave;

- ii. The period of time for which the leave is sought (including course dates and the daily commencing and finishing times); and
 - iii. The title, general description and structure of the course to be attended and the location of where the course is to be conducted.
- (e) The Employer shall advise the training provider within seven clear working days (Monday to Friday) of receiving the application as to whether or not the application for leave has been approved.
 - (f) The time of taking leave shall be arranged so as to minimize any adverse effect on the Employer's operations. The onus shall rest with the Employer to demonstrate an inability to grant leave when an eligible employee is otherwise entitled.
 - (g) The Employer shall not be liable for any additional expenses with an employee's attendance at a course other than the payment of Ordinary Time Earnings for such absence. For the purpose of this clause Ordinary Time Earnings shall be defined as the relevant Agreement classification rate including, shiftwork loadings where relevant plus Site Allowance where applicable.
 - (h) Leave rights granted in accordance with this clause will not result in additional payment for alternative time off to the extent that the course attended coincides with an employee's RDO or with any concessional leave.
 - (i) An employee on request by the Employer shall provide proof of their attendance at any course within seven days. If an employee fails to provide such proof, the Employer may deduct any amount already paid for attendance from the next week's pay or from any other moneys due to the employee.
 - (j) Where an employee is sick during a period when leave pursuant to this clause has been granted proof of attendance at the course is not required for that period and the employee shall receive payment if entitled under the provisions of **clause 39 of the Award**.
 - (k) Leave of absence granted pursuant to this clause shall count as service for all purposes of this Agreement.
 - (l) Any dispute as to any aspect of this clause shall be resolved in accordance with the dispute settlement provisions of this Agreement.

Part B – Health and Safety Training Leave

The Parties acknowledge that for Health and Safety Representatives to effectively undertake their duties they should have the appropriate level of training. The Employer recognises that a Health and Safety Representative who is well trained in matters including their rights, obligations and responsibilities under the *Occupational Health and Safety Act 2004 (Vic)* (**OHS Act**) will assist in promoting a safe working environment at the workplace. To that end the following leave provisions apply.

- (a) Subject to all qualifications in this clause, an Employee appointed or elected as an elected Health and Safety Representative shall,

upon application in writing to the Employer, be granted up to 5 days leave with pay each calendar year non-cumulative to attend courses approved by the Employer.

- i. Such courses shall be designed and structured with the objective of promoting good safety practices.
 - ii. Consultation may take place between the Parties in the furtherance of this objective.
- (b) For the purposes of this Part B, a “*health and safety representative*” shall mean “a member of a designated work group elected to represent the designated work group on matter relating to occupational health and safety” and/or an Employee recognised by the Employer in accordance with **clause 58** of this Agreement.
- (c) In addition to this entitlement HSRs are entitled to request an additional two days training for the purposes of improving their skills and capabilities for mental health and wellbeing initiatives, and/or the prevention of bullying, discrimination and harassment in the workplace. Such a request will not be unreasonably refused.
- (d) The following scale shall apply:

No. of employees covered by this Agreement	Maximum No. of Health and Safety Representatives eligible to attend per year	Maximum No. of days permitted per year
Up to 15	1	5
16 – 30	2	10
31 – 50	3	15
51 – 100	4	20
101 and over	5	25

- (e) Any application for leave under this Part B shall be given to the Employer at least 4 weeks in advance of the date of commencement of the course. The application for leave shall contain the following details:
- i. The name of the Health and Safety Representative seeking the leave;
 - ii. The period of time for which the leave is sought (including course dates and the daily commencing and finishing times); and
 - iii. The title, general description and structure of the course to be attended and the location of where the course is to be conducted.

- (f) The Employer shall advise the Employee and the training provider within 7 clear working days (Monday to Friday) of receiving the application as to whether or not the application for leave has been approved.
- (g) The time of taking leave shall be arranged so as to minimise any adverse effect on the Employer's operations. The onus shall rest with the Employer to demonstrate an inability to grant leave when an eligible Employee is otherwise entitled.
- (h) The Employer shall not be liable for any additional expenses associated with an Employee's attendance at training under this Part B other than the payment of Ordinary Time Earnings for such leave. For the purposes of this Part B, "Ordinary Time Earnings" shall be defined as the relevant Agreement classification rate including shift work loadings where relevant plus the Site Allowance where applicable.
- (i) Leave granted in accordance with this Part B will not result in additional payment for alternative time off to the extent that the training attended coincides with an Employee's RDO or with any concessional leave.
- (j) On request by the Employer, an Employee shall provide proof of their attendance at any course within 7 days. If an Employee fails to provide such proof, the Employer may deduct any amount already paid for the leave from the next week's pay or from any other moneys due to the Employee.
- (k) Where an Employee is entitled to Personal/Carer's Leave or Sick Leave during a period of leave pursuant to this Part B, proof of attendance at the course is not required for that period and the Employee shall instead receive Personal/Carer's or Sick Leave.
- (l) Any leave of absence granted pursuant to this clause shall count as service for all purposes of the Award and this Agreement.
- (m) Any dispute as to any aspect of this clause shall be resolved in accordance with the dispute settlement provisions of this Agreement.

APPENDIX F – Passenger and Material Lifts

SECTION I 1. Definition of Building Where Lift Required

- 1.1 A passenger/materials lift shall be provided on a building which shall, when complete, consist of more than six (6) storey levels excluding the roof, parapets and basement levels (if any), but including the ground floor. (Refer to Sub clause 2 of this Appendix.)
- 1.2 For the purposes of this Sub-Clause, a storey level means structurally completed floor, walls, pillars or columns, and ceilings (not being false ceilings), and shall include mezzanine or similar levels, but excluding “half floors” such as toilet blocks or store rooms located between floors.
- 1.3 For the purpose of defining the number of story levels in a building; where any plant or similar structure does not exceed 25 per of the top floor area, such plant room or similar structure shall not be counted as a storey level or levels as the case may be.
- 1.4 For a building with sloping or split floors (e.g., a car park), the method of determining storey levels shall be by taking the height of that building and dividing its height by the average floor height of a building which does not have sloping or split floors.

SECTION II 2. When Lift Required

- 2.1 The passenger/materials lift shall be in operation from the date of commencement of formwork erection above the floor level of the fifth storey (prior to commencing pours for the floor level of the fifth storey) when counted from the lowest adjacent street level or where the basement excavation level is more than 5 levels down from the lowest adjacent street level. Floor level means that stage of construction which, in the completed building, would constitute the walking surface of each particular floor level.
 - 2.2 Where the basement exceeds 5 levels, and due to operational constraints it is not possible to install a hoist until the final base excavation level is reached, a Deep Basement Excavation Allowance will apply in accordance with **clause 3** of this Appendix. A Deep Basement Excavation Allowance will apply to all Employees required to work below the 5th basement level until base excavation level is reached. Once base excavation level is reached the Employer will ensure that a hoist is installed.
- 3 Deep Basement Excavation Allowance
- (b) As of 1 March 2024 where Employees are entitled to a Deep Basement Excavation Allowance, they will receive the amount of \$9.70 per hour.

This allowance will be adjusted annually in accordance with CPI (All Groups, Melbourne) movements measured in the twelve month period ending the previous December quarter effective as of 1 March 2025, rounded to the nearest 5 cents.
- 3.1 Employees will not be required to walk down from the ground floor more than four (4) levels. However, the Employer and the Union accept that from time to

time there will be occasions where an alternative arrangement will need to be implemented.

SECTION III 3. Operation of Lift

- 3.1 The mode of operation of the passenger/materials lift shall be at the discretion of Management, but there shall be landings at intervals of not more than four (4) storey levels. Subject to sub-clause 3.3, an employee would not be required to walk either up or down more than two (2) floors within the range of the lift, or more than four (4) floors within the range of the lift.
- 3.2 When the building has risen so that the formwork exceeds floors above the lift travel, the lift travel shall be extended.
- 3.3 If mechanical or power failure puts the passengers/materials lift out of action, Management must endeavour to correct the failure as soon as possible and have the passengers/materials lift back in use. During such temporary stoppage of the passengers/materials lift, the employees are expected to walk to their place of work to a maximum of four (4) levels to work in their respective classification, and no industrial action or dispute should take place. In the case of the service core, refer to **clause 26.18(f)** of the Agreement.
- 3.4 When lifts are also used to carry materials, preference must be given to the transporting of employees at the starting, finishing and lunch times. Starting times of various Trades may be staggered by agreement to avoid lift congestion at starting and finishing times.
- 3.5 Should a crane or cranes on a building not be able to operate (e.g., because of wind or mechanical failure), employees will continue to work to a maximum of four (4) levels above the range of the lift, provided that the appropriate emergency service is satisfied that it is capable of being able to provide first aid attendance, and removal if necessary, to/of any employee on any section of the Project without the use of the crane/s.
- 3.6 Subject to the provisions of the relevant OH&S legislation, the Lift Diver(s) shall remain on site to operate the lift to carry passengers.

HOIST NOT REQUIRED TO BE ERECTED

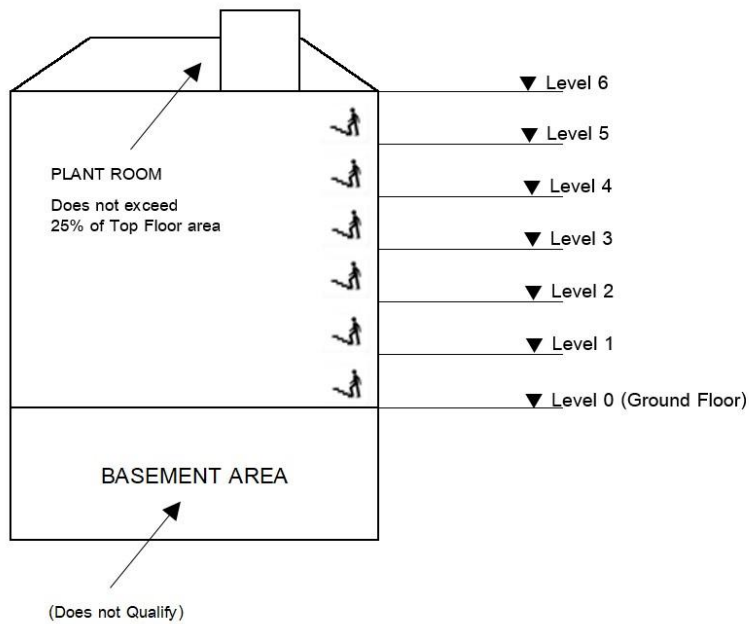
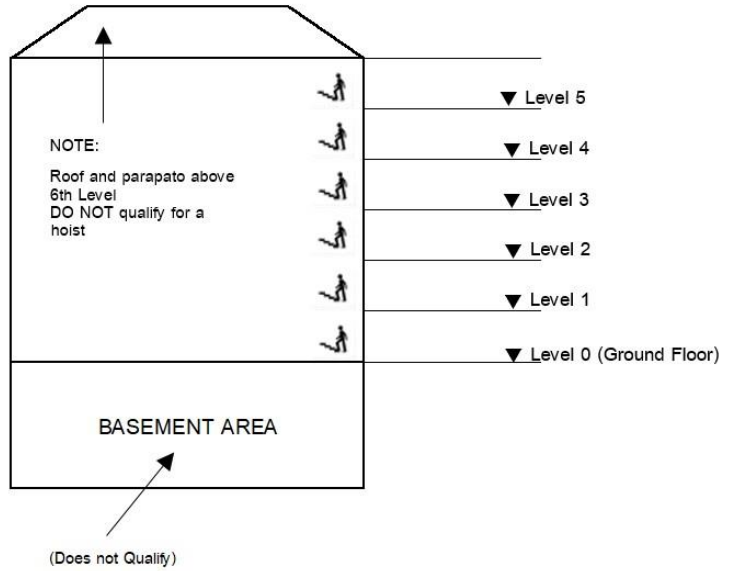

WHEN HOIST IS REQUIRED TO BE ERECTED

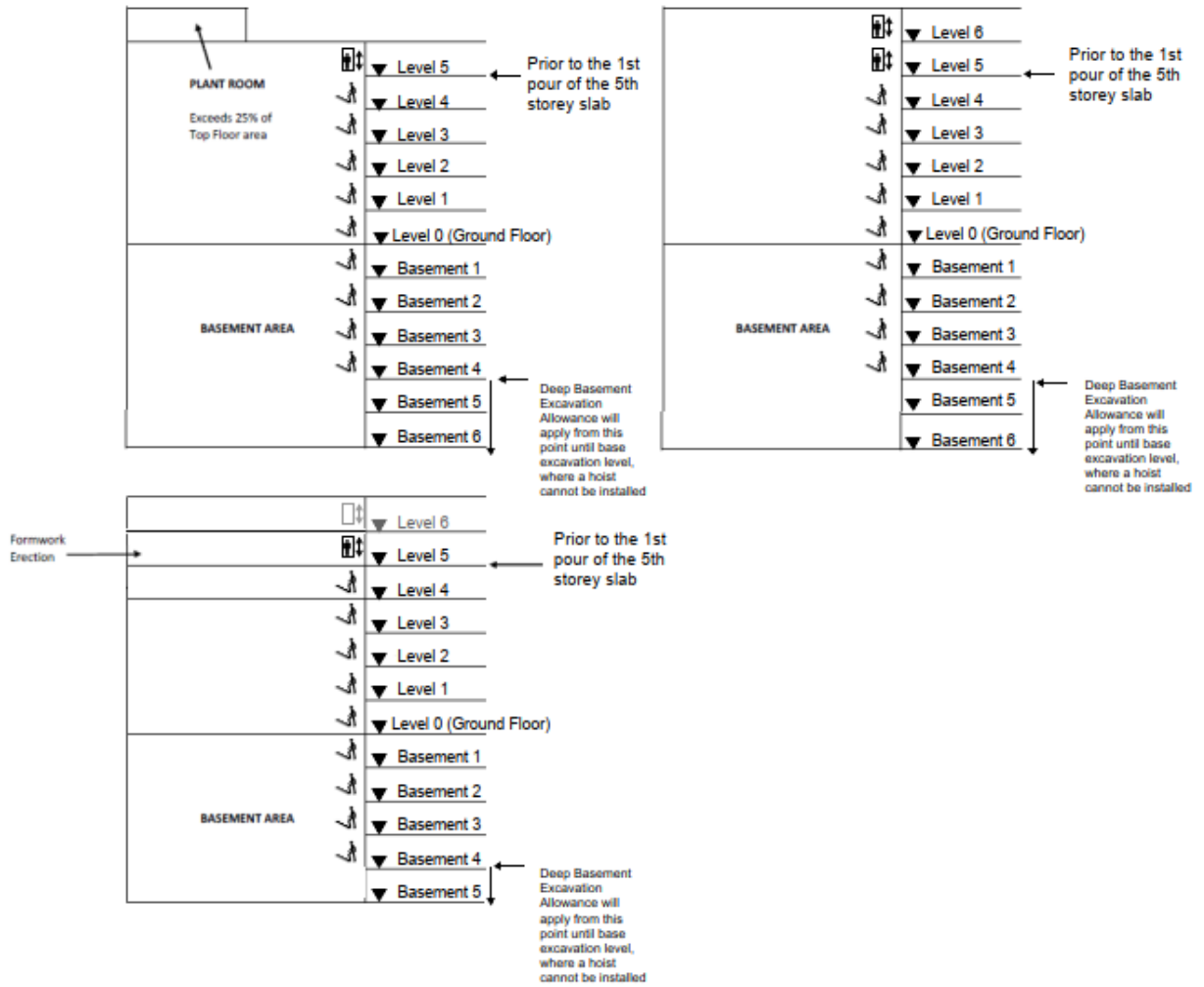

APPENDIX G – Drug and Alcohol Management Program

1.0 PROJECT DRUG & ALCOHOL MANAGEMENT PROGRAM (DAMP) PROCESS

- 1.1 Context**
- 1.2 Revision Status**
- 1.3 Controlled Document Distribution Status**
- 1.4 Definitions**
- 1.5 Confidentiality**

2.0 DUTY OF CARE AND RESPONSIBILITY

- 2.1 Employers**
- 2.2 Management of test results**
- 2.3 Project Manager**
- 2.4 [Insert Company] Health, Safety & Environmental Manager**
- 2.5 Supervisors/Line Managers**
- 2.6 Health & Safety Committee**
- 2.7 Workers & Other Persons**

3.0 EDUCATION & COMMUNICATION

- 3.1 Initial Training**
- 3.2 Accredited Training**
- 3.3 D&A Officer**
- 3.4 Inductions**
- 3.5 Distribution of Information**
- 3.6 Additional Information**
- 3.7 Medical conditions that may affect Fitness for Duty**

4.0 SUPPORT

- 4.1 Available support**
- 4.2 Employee Assistance Provider (EAP)**

5.0 REGULAR TESTING

- 5.1 Selection Process**
- 5.2 Testing Process**

6.0 DRUG & ALCOHOL TESTING (1ST STEP)

- 6.1 Principle**
- 6.2 Self-Testing**
- 6.3 For Cause Testing**
- 6.4 Reasonable Concern Testing**

7.0 TESTING PROCEDURE (2ND STEP)

7.1	Self-Testing
7.2	For Cause or Reasonable Concern testing procedure
8.0	TESTING METHODS FOR DRUGS & ALCOHOL
8.1	Alcohol Testing Method
8.2	Drug Testing Method
9.0	TESTING RESULTS
9.1	Principle
9.2	Drug Testing
10.0	CONSEQUENCES
10.1	Self-Testing
10.2	Alcohol Test
10.3	Drug Testing
10.4	Refusal to Test
10.5	Disciplinary Action
10.6	Self-Declaration
11.0	CONFIDENTIALITY
11.1	Confidentiality of Information
11.2	Confidentiality of Results
11.3	[Insert Company]’s Duties
11.4	Release of Information
12.0	CONSULTATION
12.1	Amendments to DAMP
12.2	Aim 15
	APPENDIX A - OBSERVABLE IMPAIRMENT ASSESSMENT CHECKLIST
	APPENDIX B – DRUG & ALCOHOL COUNSELLING ADVICE
	APPENDIX C – TEST TARGET CONCENTRATIONS
	APPENDIX D – EXAMPLE DRUG TESTING CONSENT AND CHAIN OF CUSTODY FORM

1.0 PROJECT DRUG & ALCOHOL MANAGEMENT PROGRAM (DAMP) PROCESS

1.1 Context

This process describes the Drug and Alcohol Management Program (DAMP) within nominated [Insert Company] workplaces in Victoria.

This process applies to all workers, contractors and visitors, and on all nominated projects. Contractors will be required to comply with the requirements in this DAMP as per the contractual agreement. Where [Insert Company] is involved in an alliance or joint venture, this process is to be maintained as a minimum requirement.

The purpose of this process is to manage alcohol and other drugs and their effects on workers' fitness for work whilst performing duties or attending the workplace. This process ensures that [Insert Company] has a mechanism to appropriately manage the misuse of alcohol and other drugs in the workplace through education, counselling, rehabilitation and discipline, where required. Drug and Alcohol tests will be conducted for the following substances on [Insert Company] projects:

- Alcohol;
- Opiates;
- THC (marijuana or cannabis);
- Cocaine;
- Benzodiazepines;
- Amphetamine; and
- Methamphetamine.

1.2 Revision Status

Revisions to this Management Plan will be made as required to reflect the current site conditions and to ensure the continued suitability and effectiveness. The frequency of the review shall be determined by the Project Manager and workplace conditions but shall not exceed 12 months.

Version	Date	Description	Page	Site Manager	Project Manager

1.3 Controlled Document Distribution Status

Amendments to this Management Plan are approved by the Project Manager, and distributed to all holders outlined below:

Date	Name of Recipient	Organization

Definitions

Accredited Laboratory means a laboratory which meets minimum Australian performance standards set by an accrediting agency, being the National Australian Testing Authority (NATA).

Alcohol refers specifically to the chemical substance ethanol which, in this context may occur in either a liquid or gaseous form.

Amphetamine-type stimulants may include, but are not limited to, the following: amphetamine, Methylamphetamine, Methylenedioxyamphetamines (MDA), Methylenedioxyamphetamine (MDA).

B.A.C is the measurement of alcohol in the body, in grams of alcohol per 100 millilitres of blood and recorded as a percentage i.e. 0.00%.

Benzodiazepine is medications that are frequently prescribed for the symptomatic treatment of anxiety and sleep disorders.

Chain of Custody is a series of procedures to account for the integrity of each oral fluid specimen by tracking its handling and storage from point of collection to final disposal.

Cocaine includes cocaine and its metabolites including cocaine, Benzoyllecgonine and Ecgonine methyl ester.

Confirmatory Test refers to a second alcohol breath test to confirm the initial reading or, in the case of drugs, an oral fluid analysis conducted at an accredited laboratory to confirm the non-negative ("fail") result obtained in the initial test. The confirmatory test results in a definitive positive (fail) or negative (pass) result.

Confirmed Positive Result (Fail) means a:

Secondary onsite breath test for alcohol in excess of 0.00 grams per 100 milliliters (0.00%) of alcohol;

Secondary test conducted at an accredited laboratory for drugs in excess of the levels contained in AS 4760:2006, performed at an accredited laboratory. Note: Benzodiazepine level¹ to be provided by the prescribed testing laboratory.

A confirmed positive result as described above is a fail.

Drug means a substance that has a physiological effect on the body, either by itself or through its metabolite(s). The term 'drug' refers to the drug and/or its metabolite(s) for the purpose of detecting a target drug in oral fluid.

Employee Assistance Program (EAP) provides assistance to [Insert Company] workers and their families.

Fit for Work means a person who has a BAC of 0.00% and tests negative for the list of substances noted in Appendix C of this document.

For Cause Testing is drug and alcohol testing which may be carried out for any of these scenarios:

An individual or group of individuals' fitness for work may have been a contributing factor in an incident.

There is a direct observation or indication of impairment or unusual behaviour or actions by the individual.

Evidence or reason to believe the individual is involved with the use of alcohol or other drugs while at work.

Where safety precautions or processes may have been breached by the individual.

H&S means health and safety.

Health and Safety Committee is defined as per *Victorian Occupational Health and Safety Act 2004*.

Health and Safety Representative (HSR) means a member of a designated work group elected to represent the designated work group on matter relating to occupational health and safety;

Initial Screening Test is defined as indicative testing conducted at the workplace to exclude the presence of alcohol and/or a drug or a class of drugs as provided by Australian Standards AS3547:1997 and AS 4760:2006. The Initial Screening Test provides a "negative" or "non-negative" result. Where a "non-negative" ("fail") result is obtained, confirmatory testing must be conducted to provide a conclusive result.

NATA is the National Association of Testing Authorities, who accredits laboratories, inspection bodies and calibration services produce certified reference materials and provide proficiency testing schemes throughout Australia.

Negative Result means a test result at or below the prescribed or nominated target concentration levels and this is therefore considered a "pass".

Non-Company Personnel refers to any worker who is not directly employed by [Insert Company].

Non-Negative Result means an initial screening test result that indicates the presence of alcohol or drugs above the prescribed or nominated target concentration levels and is therefore considered a

¹ Benzodiazepine concentrations are to be confirmed with [Insert Company]'s chosen Drug & Alcohol testing provider.

“fail”. A secondary onsite breath test for alcohol or accredited laboratory test for drugs is to be conducted to determine a confirmed positive (fail) or confirmed negative (pass) result.

OHS Act means *Victorian Occupational Health and Safety Act 2004*.

Opiates may include but are not limited to the following: morphine, codeine and 6-acetylmorphine.

Over-the-Counter Medication means medicines/drugs sold directly to the consumer without a prescription from a healthcare professional.

Prescription Medication means medication that is prescribed by a healthcare professional.

Random Testing refers to drug and alcohol testing completed at the workplace on a randomly selected day and time (keeping within the parameters defined in this procedure, e.g. testing required monthly) on a randomly selected group of individuals or teams.

Targeted Testing refers to testing conducted for the workers working in high risk activities or once returning to work after a confirmed positive (fail) drug or alcohol test.

Testing Officer means a suitably competent and trained provider or person approved by the HSE Manager to conduct drug and alcohol sampling of the workers at the workplace. This person may be an independent person or employed by [Insert Company].

THC refers to tetrahydrocannabinol, also known as marijuana or cannabis.

Worker means:

- a worker (including salaried, staff and managerial personnel), or
- a contractor or subcontractor, or
- a worker of a contractor or subcontractor, or
- a worker of a labour hire company who has been assigned to work in the person’s business or undertaking, or
- an outworker, or
- an apprentice or trainee, or
- a student gaining work experience, or
- a volunteer, or
- a visitor, or
- a consultant.

Workplace means a place where work is carried out for a business or undertaking and includes any place where a worker goes, or is likely to be while at work, including all facilities provided to the workers for the purpose of conducting works for [Insert Company]. A workplace includes, but is not limited to:

- site/project office
- plant and laydown yards
- car parks
- sheds and rooms
- amenities
- working locations
- shipping containers and site safes
- company vehicles

This process applies not only to [Insert Company]’s sites, but also on any other site that workers are acting as representatives of the company.

1.2 Confidentiality

All information gathered as a result of alcohol and other drug testing is collected for the purpose of implementing this process.

[Insert Company] is committed to ensuring that results from all drug and alcohol testing remain confidential and use/access/dissemination of the results shall be restricted to those who have a genuine requirement to access the results of the drug and/or alcohol test.

2.0 DUTY OF CARE AND RESPONSIBILITY

Under this process the duty of care, responsibilities and obligations of [Insert Company], the workers, contractors and others at the workplace are derived from obligations under the *Victorian Occupational Health and Safety Act 2004* and specified responsibilities detailed in this process.

2.1 Employers

Employers must provide a safe and healthy workplace for the workers or other persons by ensuring, so far as is reasonably practicable:

- Safe systems of work
- A safe work environment
- Safe use of plant, structures and substances
- Facilities for the welfare of the workers are adequate
- Notification and recording of workplace incidents
- Adequate information, training, instruction and supervision is given
- Compliance with the requirements under the Occupational Health and Safety Regulation 2007
- Effective systems are in place for monitoring the health of workers and workplace conditions.

2.2 Management of test results

The Health, Safety & Environmental (HSE) Manager is responsible for receiving and maintaining the laboratory results for all positive and non-negative test results from each project.

For all positive and non-negative (fail) alcohol or drug test results, [Insert Company] will have one central database to record and to monitor disciplinary action should a worker have a 1st, 2nd or 3rd infraction. A copy of the Chain of Custody document with the presumptive test results could be forwarded to [Insert Company] which will then inform the Subcontractor line manager of the confirmatory result for each employee.

2.3 Project Manager

The Project/Construction Workplace (P/CW) Manager is responsible for ensuring, so far as is reasonably practicable, adequate resources are allocated for the implementation, education, training and support of this process. The P/CW must also ensure this process is applied fairly and consistently.

2.4 Health, Safety & Environmental Manager

The Health, Safety & Environmental (HSE) Manager is responsible for ensuring this process remains current, is readily available and is applied in the way it was intended. The HSE Manager must also ensure, so far as is reasonably practicable, that all the workers know and understand the Drug and Alcohol Management Program (DAMP).

2.5 Supervisors/Line Managers

Supervisors/Line Managers must ensure, so far as is reasonably practicable, that all individuals in their area of responsibility understand and comply with the requirements of this process and ensure that no worker commences or continues work if the worker appears to be affected by alcohol or other drugs. In this case, the matter should be referred to the P/CW Manager for further investigation or action, as applicable.

2.6 Health & Safety Committee

It is the role of the Health and Safety Committee to assist with consultation between [Insert Company] and the workers in instigating, developing and carrying out measures designed to ensure the health and safety of the workers at work.

2.7 Workers & Other Persons

The *Victorian Occupational Health and Safety Act 2004* requires that a Worker must, while at work:

- Take reasonable care for their own health and safety
- Take reasonable care for the health and safety of other workers who may be affected by the worker's acts or omissions, and
- Cooperate with his or her employer with respect to any action taken by the employer to comply with requirements imposed by the Act, Regulations or guidelines.

It is the responsibility of the worker to present in a fit state for work and have the appropriate level of rest afforded to them between shifts. Any worker, who believes that he or she may be unfit for work for any reason is expected to not commence work and to inform his or her employer accordingly.

Workers should notify their Supervisor/Line Manager if they are taking medication of any kind which may impair their ability to conduct work safely. Workers should also notify their Supervisor/Line Manager if they have an alcohol or drug issue which may be in breach of the requirements in this process.

Workers must also notify their Supervisor/Line Manager when they become aware of any breach or potential breach of this process.

3.0 EDUCATION & COMMUNICATION

3.1 Initial Training

[Insert Company] must provide initial training for each worker covering all of the following matters (e.g. site / inductions, formalized training):

- The health and safety implications of drug and alcohol use.
- Medications which may affect the worker's ability to work safely.
- Medications and other factors which may trigger a non-negative result.
- Recognition of the early indication of drug and alcohol abuse.
- The adverse effects that drugs and alcohol may have on health, and the related risks to safety and the environment.
- Treatment and rehabilitation, including [Insert Company]'s Employee Assistance Program (EAP).
- Resources available for counselling and/or rehabilitation and the procedures for obtaining assistance or referring workers for assistance.
- The contents and requirements of this drug and alcohol clause.
- Levels of drug and alcohol consumption.
- The use of available alcohol testing equipment for personnel who wish to test themselves voluntarily before the start of their normal shift.

3.2 Accredited Training

[Insert Company] will provide accredited training for staff and [Insert Company] representatives to recognize impaired performance resulting from drug and alcohol abuse, and to handle the resulting worker relations issues. The worker's representatives shall be called a D&A Impairment Officer.

3.3 D&A Officer

[Insert Company] shall have at each nominated construction project, a worker who has successfully completed unit HLTPAT005 – *Collect specimens for drugs of abuse testing*, or equivalent. Such worker shall be called the D&A Officer.

3.4 Inductions

The [Insert Company] induction will include a specific section on drugs and alcohol, which will be reinforced with toolbox briefings and the abovementioned training.

3.5 Distribution of Information

[Insert Company] shall place printed safety material placed on noticeboards and/or distributed in workplace amenities.

3.6 Additional Information

[Insert Company] will not perform any drug and alcohol testing or take any disciplinary action against an affected worker in respect of drugs and alcohol, until the worker has completed the initial training as detailed in clause 3.1 of this process.

This training will be included in workplace inductions.

3.7 Medical conditions that may affect Fitness for Duty

Workers may have legitimate medical reasons for taking lawful drugs for medical purposes or where the drug is lawfully available at pharmacies.

If a worker has a medical condition that could affect fitness for Duty, he/she should inform the Supervisor, and a worker representative if he/she so wishes. The individual is not obliged to disclose confidential medical information unless it is relevant to their ability to safely perform their role.

If a worker's ability to safely perform normal work duties is affected by taking prescription or pharmacy drugs, the worker should obtain this advice in writing from the medical practitioner and/or pharmacist and provide it to the supervisor, and worker representative if he/she so wishes, as soon as practicable.

Any worker required to participate in drug testing is obliged to declare to the tester any medication taken immediately prior to the test being conducted. Such information will be kept confidential and only used in determining if such medication has contributed to or caused a non-negative result.

If the worker declares the medication which results in a non-negative result prior to any testing being conducted, the worker will be deemed unfit for work until the drug class declared is confirmed by a testing laboratory. Subject to a medical practitioner confirming & outlining the effects on fitness for work, no action will be taken against the worker in these instances.

If the worker did not declare the medication prior to the testing being conducted, then the Consequence clause below will apply, unless the worker can prove subsequently he/she has taken the medication which has resulted in the positive result or sufficient evidence is provided by a medical practitioner outlining the medication taken (consistent with the drug test result) and the effects on fitness for work.

4.0 SUPPORT

4.1 Available support

[Insert Company] will make available support to the workers in respect of drug and alcohol issues. This will include:

- allowing access to any Union support programs; and
- Providing access to [Insert Company] Employee Assistance Program (EAP).

4.2 Employee Assistance Provider (EAP)

The worker will be allowed to access EAP counselling during normal working hours and without loss of pay. An agreed leave of absence arrangement or loss of pay is to apply for matters outside of this EAP counselling as agreed between [Insert Company] and the worker.

5.0 REGULAR TESTING

Regular drug and alcohol testing (for substances as per Appendix C) will be conducted on a monthly basis involving all workers (as defined by clause 1.4 definition) on the project. Testing will be conducted based on the following scales:

- Where there are less than 30 workers on site, a minimum of 10% of the workforce will be tested.
 - Where there are 30 to 100 workers on site, a minimum of 5 workers will be tested.
 - Where there are greater than 100 workers on site, a minimum of 10 workers will be tested.
-

- Visitors will be subject to for cause testing only

5.1 Selection Process

Workers will be selected for testing using a random selection process nominated by management following a consultation process in line with *Victorian Occupational Health and Safety Act 2004*.

5.2 Testing Process

[Insert Company] will ensure regular selection of workers to complete the testing will be conducted in a clear and transparent manner in the presence of the Drug and Alcohol Officer, Drug and Alcohol Impairment Officer and a Health and Safety Representative/Committee member where appointed.

6.0 DRUG & ALCOHOL TESTING (1ST STEP)

6.1 Principle

NB: This clause does not limit the random testing required under clause 5

The Parties agree that the pre-conditions to testing as set out in this clause represent a proper balance of ensuring a safe workplace and protecting privacy and associated rights of workers.

[Insert Company] shall only request a worker to undertake "for cause" or "reasonable concern" testing if the criteria set out below for "for cause testing" or "reasonable concern testing" are satisfied.

A worker may voluntarily test. This process is dealt with below in the section dealing with "Self-testing".

The following are the only testing processes and techniques that can be used to undertake "for cause" or "reasonable concern" or "self-testing". Any failure to comply with this clause will render the tests invalid, and no action will be taken against the worker in connection with the results of a non-complying test.

6.2 Self-Testing

Facilities will be made available for workers choosing to undertake a self-test for alcohol and/or drugs. The number of workers self-testing should not exceed 10% of the total workforce per month.

6.3 For Cause Testing

[Insert Company] may only request a worker to undertake for cause testing if the following criteria are met:

- The worker has been involved in an accident or incident, or had the potential to, cause:
 - Serious and major damage to mobile plant or property; or
 - An injury to himself/herself or other individual(s).
- Participation in a relevant and specific Industry focus area when the worker is undertaking High Risk Work as identified by [Insert Company]. Workers will be selected for testing using a random selection process nominated by [Insert Company] management following a consultation process in line with OHS legislation.

6.4 Reasonable Concern Testing

[Insert Company] may only request a worker to undertake reasonable concern testing if the following criteria are met:

An observable phenomena occurs, which is:

- the direct observation of the worker of using, and/or the physical behavioural symptoms of being impaired by, alcohol and/or other drugs; and/or
 - unusual and/or inexplicable actions by the worker;
 - There is evidence that the worker is involved in the use or possession of alcohol and/or other drugs while working; or
 - The worker has breached safety provisions or procedures.
-

7.0 TESTING PROCEDURE (2ND STEP)

7.1 Self-Testing

The following process is designed to encourage self-testing where a worker is unsure of their fitness for work. Self-testing will be done in accordance with the following:

- [Insert Company] will provide workers with private and confidential facilities and equipment to self-test for alcohol and/or drugs on a “without prejudice” basis before starting work.
- The worker who seeks to self-test for alcohol shall do so in accordance with the relevant testing method below.
- The worker, who seeks to self-test for drugs, shall advise the D&A Officer of this.
- The D&A Officer shall then conduct the relevant testing method below if requested.

7.2 For Cause or Reasonable Concern testing procedure

If the pre-conditions for “For Cause or Reasonable Concern” testing have been satisfied, the following procedure may be engaged in.

[Insert Company] shall firstly meet with the worker, who will be given the opportunity to have a representative of their choice present where practicable. At this meeting:

- [Insert Company] shall advise the worker of the factual foundation which has satisfied the relevant pre-conditions for testing;
- [Insert Company] may request the worker to undertake an Observable Impairment Assessment (see Appendix A).
- If the worker refuses to undertake the Observable Impairment Assessment (Appendix A), then the refusal clause shall apply.
- If the worker agrees, then the ‘Observable Assessment Checklist’ is undertaken and completed in accordance with Appendix A.
- If deemed to be impaired, the worker is to be tested in accordance with the Testing Methods clause.
- If not impaired, the worker shall return to work and all records shall be destroyed.

8.0 TESTING METHODS FOR DRUGS & ALCOHOL

8.1 Alcohol Testing Method

Alcohol testing may only be done by use of an Accredited Breath Test device. The device must be calibrated and meet the minimum requirements of AS3547.

8.2 Drug Testing Method

Drug testing may only be done by oral fluid testing. The [Insert Company] DAMP requires that the following substances are tested for:

- Opiates;
- THC;
- Cocaine;
- Benzodiazepines;
- Amphetamine; and
- Methamphetamine.

The equipment used to perform the test shall be used, tested and calibrated to the manufacturer's instructions and certified to AS 4760 (Processes for specimen collection and the detection and quantitation of drug in oral fluid).

The drug testing shall be conducted by an accredited person, following all of the chain of custody provisions.

The test must be performed in accordance with AS 4760 (Procedures for specimen collection and the detection and quantitation of drugs in oral fluid).

This includes, but is not limited to:

- performing all the quality assurance requirements, such as negative and positive controls every 25 tests; the testing body must be accredited and independently audited by an organisation such as ISO or NATA;
- Collectors must be trained and receive a certificate of attainment in accordance with the Australian Quality Training Framework;
- Oral Fluid devices must have the recommended cut-off levels;
- Oral Fluid devices must undergo regular quality control checks including a positive and negative control every 25 tests, and one in 20 negative donor samples must be sent to an appropriately accredited laboratory to confirm a negative result;
- Collectors are required to explain the procedures to each donor, conduct an approved identity check, and have them complete a consent form;
- Collection and performance of the initial test must be performed in the presence of the donor; and
- An unconfirmed (non-negative) sample must be despatched under strict chain of custody procedures including a second reference sample which has been collected at the same time.

The quantification analysis of the samples detected as non-negative in the on-site device must be conducted in a NATA accredited laboratory for confirmation testing.

The above does not apply to self-testing to the extent that it is inconsistent with the self-testing regime.

9.0 TESTING RESULTS

9.1 Principle

The overarching principle of this program and testing is to identify workers who are not fit to perform the inherent requirements of their position.

Alcohol Testing

- A worker undertaking any work activities will be considered to have not passed the BAC test if their test result indicates a BAC of more than 0.00 mg/ml.

9.2 Drug Testing

- A worker will be considered to have not passed their drug test if their test result indicates they have equal to or above the relevant cut-off levels of the substances referred to in AS 4760.
- [Insert Company] shall only be advised whether the test result is positive or negative for drugs. [Insert Company] will have one central database to record and monitor disciplinary action should a worker have a 1st, 2nd or 3rd infraction. [Insert Company] will inform the relevant Subcontractor line manager of the confirmatory result for each employee. This information should be made available to the EAP provider as agreed by the worker.
- The worker shall receive the full drug test results report (as per AS 4760). Note: Benzodiazepine level to be provided by the prescribed testing laboratory.
- The results shall be provided by confidential email or in a sealed envelope, marked private and confidential from the relevant tester.

10.0 CONSEQUENCES

10.1 Self-Testing

Workers who self-test positive for alcohol and/or drugs shall advise [Insert Company] that they are unfit for work.

All reasonable assistance is to be afforded to ensure the affected worker can make their way from the workplace to a safe location without harm (e.g. taxi, lift from a friend or supervisor).

Workers who test positive for alcohol and/or drugs are required to present to the D&A Officer for self-testing prior to their next shift to conduct a test. The worker is required to provide a negative sample prior to entering the job.

An agreed leave of absence arrangement or loss of pay is to apply.

No record of testing shall be kept

Note: Self-testing does not exempt workers from being part of any other determined drug & alcohol testing

10.2 Alcohol Test

Workers who pass the alcohol test shall be permitted to return to work immediately. No individual test record is to be maintained.

Workers who do not pass the alcohol test are required to cease work and will be retested 60 minutes after initial test or at the discretion of the Testing Officer.

Workers who are retested after **60 minutes** and pass the alcohol test are permitted to return to work immediately. No loss of pay is to apply and no individual test record is to be maintained.

Where a worker is retested after **60 minutes** and does not pass the alcohol test, he/she is not permitted to return to work and shall leave the workplace when practicable. All reasonable assistance is to be afforded to ensure the affected worker can make their way from the workplace to a safe location without harm (e.g. taxi, lift from a friend or supervisor). For the period after the first **60 minutes**, an agreed leave of absence arrangement or loss of pay is to apply.

Prior to returning to work, the worker will be required to take an alcohol test on site with a Drug & Alcohol Officer present. The worker can only return to work if the test result is 0.0. BAC

10.3 Drug Testing

Workers recording a negative result (pass) are permitted to return to work immediately. No record of the test is to be maintained.

Workers recording an onsite non-negative result (fail) will NOT be permitted to return to work and the oral fluid sample will be sent immediately for confirmatory testing at an accredited laboratory in line with AS 4760. The worker shall then leave the workplace when practicable. All reasonable assistance is to be afforded to ensure the affected worker can make their way from the workplace to a safe location without harm (e.g. taxi, lift from a friend or supervisor). An agreed leave of absence arrangement or loss of pay is to apply.

Workers who have recorded an onsite non-negative result (fail), who has then subsequently recorded a negative result (pass) in the confirmatory testing, shall return to work at the start of their next allocated shift and without any loss of pay.

Workers who have recorded an onsite non-negative result (fail), who has then subsequently recorded a positive result (fail) in the confirmatory testing, shall not be permitted to return to work. An agreed leave of absence arrangement or loss of pay is to apply.

However, a worker may dispute the confirmatory test and elect to have Sample B tested at the same or an alternative NATA accredited laboratory. If the result is negative (pass), the worker may return to work with no loss of pay or disciplinary action. If the result is confirmed positive (fail) the worker will not be permitted to return to work and an agreed leave of absence arrangement with [Insert Company] or loss of pay is to apply. The cost of this Sample B testing is borne by the worker.

A worker who was required to leave the workplace for non-compliance is required to return a negative (pass) retest prior to commencing their next normal shift. An agreed leave of absence arrangement or loss of pay is to apply for the duration of their absence.

10.4 Refusal to Test

The following steps shall be undertaken if a worker refuses to participate in the abovementioned tests (excluding self-testing):

- [Insert Company], will inform the worker and the worker's chosen representative, the refusal will have the same consequences as a non-negative result, i.e. that the worker will be deemed to be unfit for work due to the presence of alcohol or drugs.
 - If the worker still refuses, [Insert Company] and the D&A Impairment Officer shall consult with the worker and the worker's chosen representative, regarding the requirements, process and
-

consequences of refusing to test and encourage him/her to partake in the test. This would be the second request to be tested.

If the worker still refuses, the refusal will be treated as a confirmed positive result, and will be subjected to the relevant consequences of such. All reasonable assistance is to be offered to ensure the worker can make their way from the workplace to a safe location without harm (i.e. Taxi, lift from a friend or Supervisor). An agreed leave of absence arrangement or loss of pay is to apply for the duration of their absence

10.5 Disciplinary Action

The following sets out the action which may be taken when a worker returns a confirmed positive result to an alcohol or drug test.

First Occasion - A worker who has received a first confirmed positive test for alcohol or drugs (other than by self-testing) will be:

- Required to attend the Support referred to in clause 4;
- Informed of the consequences of testing positive and obligation to present, or remain in a fit state;
- Informed of further disciplinary action and testing requirements should he/she have a confirmed positive result (alcohol or drug) within the next 12 months.
- Second Occasion - A worker who has received a second confirmed positive test for alcohol or drugs (other than by self-testing) within any 12 month period will be:
- Required to re-attend the Support referred to in clause 4;
- Required to participate in a rehabilitation program as per clause 4;
- Informed of the consequences of testing positive and obligation to present, or remain in a fit state;
- Given a verbal warning with diary entry placed on file; and
- Informed of further disciplinary action and testing requirements should they have a confirmed positive result (alcohol or drug) within the next 12 months.

A worker who has received three confirmed positive test results for alcohol or drugs which has been detected in a 12 month period may be dismissed under [Insert Company]'s disciplinary processes.

A worker who fails to attend EAP sessions or other support sessions may be dismissed under the worker's disciplinary processes.

[Insert Company] will liaise with & provide assistance when required, to Subcontractors in matters relating to their individual EAPs & other support processes.

No disciplinary action will be taken in respect of positive test results from a self-test.

10.6 Self-Declaration

Workers will not be disadvantaged for self-disclosure and therefore will be supported through counselling and rehabilitation processes and provided with the support contained in clause 4. In such cases the worker will be required to take accrued or negotiated unpaid leave and may return to work when fit for duty.

The worker may be suspended from any work with immediate effect in order for an assessment to be made of the duties he/she are able to perform safely and a drug and alcohol test is to be undertaken as soon as reasonably practicable.

11.0 CONFIDENTIALITY

11.1 Confidentiality of Information

All information gathered as a result of alcohol and other drug testing is collected for the purpose of implementing this process.

11.2 Confidentiality of Results

The positive/negative result from a drug and alcohol test must remain confidential information and use/access/dissemination shall be restricted to those whose role makes it necessary to have access to it.

11.3 [Insert Company]’s Duties

[Insert Company] will adhere to the following:

- Testing will be conducted in a location that maintains the privacy and dignity of the individual.
- Negative (pass) results will be destroyed. Evidence of the tests being conducted will be retained on site.
- Workers who record a non-negative (fail) result will be treated at all times in a respectful and non-judgemental manner by all involved in the management of the matter.
- Positive and non-negative (fail) alcohol or drug test results will be retained on file until 12 months has elapsed since the most recent positive/non-negative result.

11.4 Release of Information

[Insert Company] will only release information to a third party as required by law.

12.0 CONSULTATION

12.1 Amendments to DAMP

If a Party believes that an amendment to the DAMP is required, it shall request and organize a consultation meeting involving [Insert Company], the relevant Union and the Drug & Alcohol Officers if appointed.

12.2 Aim

The attendees shall seek to reach agreement on any proposed amendments.

APPENDIX A - OBSERVABLE IMPAIRMENT ASSESSMENT CHECKLIST

Assessment of a person is to be made in accordance with this list of observable indicators in the context of changes to a person’s behaviour. The following 2 persons must perform and sign off on the assessment:

- A [Insert Company] Management Representative who has had training in D&A impairment awareness.
- A worker Representative who has had training in D&A impairment awareness.

At least one (1) of the physical indicators must be satisfied and agreed between the abovementioned persons for a reasonable suspicion of impairment to be established.

Emotional effects (the second part of the table) shall not be used as indicators of reasonable suspicion but may be recorded as additional information and for comment.

DETAILS:	
Name of Individual being Assessed:	
Date/Time:	
Contact Number:	
Name of Responsible Persons (Management Representative & Worker Representative)	
ASSESSMENT TRIGGER:	
List Behaviour / Actions / Observations noted prior to this assessment:	

CFMEU (Victorian Construction and General Division) Subcontractors Concrete Kerb,
Channel & Pavement Enterprise Agreement 2024-2027

DETAILS:	
PHYSICAL INDICATORS	
INDICATOR	OBSERVED – Yes/No
Strong smell of alcohol on the breath	
Slurred, incoherent or disjointed speech (losing track)	
Unsteadiness on the feet	
Poor coordination / muscle control	
Drowsiness or sleeping on the job during work breaks	
Inability to follow simple instructions	
Nausea / vomiting	

DETAILS:

Reddened or bloodshot eyes	
Jaw Clenching	
Sweating / hot and cold flushes	
EMOTIONAL INDICATORS (Not a basis for reasonable suspicion)	
INDICATOR	OBSERVED – Yes/No
Loss of inhibition	
Aggressive or argumentative behaviour	
Irrational	
Intense moods (sad, happy, angry)	
Quiet and reflective	
Talkative	
Increased confidence	

CFMEU (Victorian Construction and General Division) Subcontractors Concrete Kerb,
Channel & Pavement Enterprise Agreement 2024-2027

Appearance or behaviour is out of character'				
BREATH				
Smell of intoxicating liquor:	r Nil	r Slight	r Strong	
Other:				
SKIN				
r Normal/Pale	r Excessive Perspiration	r Flushed		
Other:				

OBSERVATION CHECKLIST (CONT):

CLOTHING				
r Orderly	r Soiled	r Disarranged		
Other:				
ATTITUDE: <i>(Circle the appropriate description(s))</i>				
Co-operative	Evasive	Anxious	Excited	Drowsy
Relaxed	Irritable	Indifferent	Hostile	Cocky
Sedated	Antagonistic	Depressed		
Other:				
ACTIONS: <i>(Circle the appropriate description(s))</i>				
Fighting	Swearing	Hiccups	Belching	Runny Nose
Talkative	Hallucinations	Crying	Restlessness	Dribbling
Vomiting	Constant Scratching	Unable to follow instructions		

CFMEU (Victorian Construction and General Division) Subcontractors Concrete Kerb,
Channel & Pavement Enterprise Agreement 2024-2027

OBSERVATION CHECKLIST (CONT):				
Other:				
EYES: <i>(Circle the appropriate description(s))</i>				
Normal	Watery	Glazed	Bloodshot	Eyelids Drooping
Pupils Enlarged	Pinpoint Pupils	Rolling Eyes		
Other:				
BREATHING: <i>(Circle the appropriate description(s))</i>				
Normal	Short	Jerky	Rapid	Shallow
Slow				
Other:				
SPEECH: <i>(Circle the appropriate description(s))</i>				
Normal	Incoherent	Slurred	Confused	Fast
Slow				
Other:				
BALANCE: <i>(Circle the appropriate description(s))</i>				
Unsteady	Swaying	Slumping	Falling	
Other:				
MOVEMENT/WALKING: <i>(Circle the appropriate description(s))</i>				
Needs Support when Walking	Sluggish	Staggering/Clumsy	Uncontrolled Muscle Movement / Jerky	Tremors
Other:				
AWARENESS: <i>(Circle the appropriate description(s))</i>				

CFMEU (Victorian Construction and General Division) Subcontractors Concrete Kerb,
Channel & Pavement Enterprise Agreement 2024-2027

OBSERVATION CHECKLIST (CONT):

Identify Colleagues	Day/Date	Time	Place	Recent Events
Other:				

QUESTIONS

Can you give any reason for your appearance and behaviour as noted above:

Response:

Could you be under the influence of drugs and/or alcohol?

Response:

Have you consumed drugs and/or alcohol since the commencement of the shift?

Response:

ASSESSMENT RESULT *(Both responsible persons must agree)*

No Testing Required (alternate action if applicable – note in comments below)	
---	--

--	--

Testing required – At least one (1) physical indicator in evidence	
--	--

--	--

Both responsible person(s) agree	Person 1	Person 2
----------------------------------	----------	----------

--	--	--

COMMENTS *(including mitigating factors noted or explained by the person, emotional factors identified above, further actions to be undertaken may include the following:)*

COMMENTS (including mitigating factors noted or explained by the person, emotional factors identified above, further actions to be undertaken may include the following:)

COMPLETION OF ASSESSMENT

Name of Person Assessed		
Signature:		Date:
Name of Responsible Person 1		
Signature:		Date:
Name of Responsible Person 2		
Signature:		Date:

APPENDIX B – DRUG & ALCOHOL COUNSELLING ADVICE

Alcoholics Anonymous (AA)

National Tel: 1300 22 22 22

24 hour Helpline: 1300 22 22 22

Australian Drug Foundation (ADF)

Tel: 1300 858 584

www.druginfo@adf.org.au

Directline

Tel: 1800 888 236

www.directline.org.au

Directline is a state-wide alcohol and drug service that provides phone counselling, information and referral.

IncoLink Support Services - Cardigan Street

Unit 11, 233 Cardigan Street
Carlton VIC, 3053

Telephone: (03) 9668 3061

Mobile: 0419 568 605

Family Drug Help

Tel: 1300 660 068

www.familydrughelp.org.au

Support, information, education, inspiration and encouragement for family members of people who use drugs.

Family Drug Support

Tel: 1300 368 186

www.fds.org

Support for families faced with problematic drug use.

Lifeline

Tel: 13 11 14

www.lifeline.org.au

If you are feeling suicidal or that you just can't cope then call Lifeline.

MATES in Construction

24 hour Helpline: 1300 MIC 111 (1300 642 111)

Narcotics Anonymous

www.na.org.au

What the [Insert Company] Employee Assistance Program (EAP) assists direct employees with:

The [Insert Company] EAP will help you to identify, explore and manage any issues impacting your life, which can include:

- Conflict and communication
- Maximizing performance
- Depression, anxiety and stress
- Relationship and marital problems
- Children or family member concerns
- Grief and bereavement
- Elder care issues
- Addictions
- Career path issues
- Retirement
- Work life balance
- Work stress

By calling the toll free number below you can arrange an appointment in Australia at a convenient time and location.

Tel: 1800 808 374 – Assure Programs

What you need to know...

Where does counselling take place?

It's up to you! [Insert Company] can provide counselling services over the phone or off-site, face to face at one of our national locations.

Who are the counsellors?

All Assure counsellors are highly professional qualified psychologists and social workers, with peak industry body accreditation and experience.

Who pays for the service?

[Insert Company] has an EAP which is free for direct workers and any eligible immediate family members.

How long are EAP Sessions?

Each EAP session lasts about an hour. You will also have access to the new member portal, which has an abundance of wellbeing resources and self-help tools.

Further Information

Further information may be obtained from the HSE and HR Teams.

APPENDIX C – TEST TARGET CONCENTRATIONS

Test cut off concentrations in accordance with Australian Standard AS3547:1997 Breath alcohol devices for personal use and AS 4760:2006 Processes for specimen collection and the detection and quantitation of drugs in oral fluid.

ALCOHOL TESTING THRESHOLD

Alcohol	BAC
Alcohol	0.00%

DRUG TEST THRESHOLDS

From Table 3.1, AS 4760:2006, On-site Initial Test Target Concentrations

Class of Drug	Target Concentration (ng/mL)
Opiates	50
Amphetamine-type stimulants	50
□9 tetrahydrocannabinol (THC)	25
Cocaine and metabolites	50

Note: These targets represent the undiluted oral fluid concentration.

From Table 4.1, AS 4760:2006, Laboratory Immunoassay Initial Test Target Concentrations

Class of Drug	Target Concentration (ng/mL)
Opiates	50
Amphetamine-type stimulants	50
□9 tetrahydrocannabinol (THC)	25
Cocaine and metabolites	50

Note: These targets represent the undiluted oral fluid concentration.

From Table 5.1, AS 4760:2006, Non-Immunoassay Initial Test and Confirmatory Target Concentrations

Compound	Target Concentration (ng/mL)
Morphine	25
Codeine	25
6-Acetyl morphine	10
Amphetamine	25
Methylamphetamine	25
Methylenedioxymethamphetamine	25
Methylenedioxyamphetamine	25
tetrahydrocannabinol (THC)	10
Cocaine	25
Benzoylcegonine	25
Ecgonine methyl ester	25

Notes:

1. These targets represent the undiluted oral fluid concentration.
2. For analysis not included in this Table, the laboratory should select a target concentration as appropriate for oral fluid.

Note: Benzodiazepine target concentrations to be confirmed with the laboratory used.

13.0

APPENDIX D – EXAMPLE DRUG TESTING CONSENT AND CHAIN OF CUSTODY FORM

Project	
Schedule agreed by	
Name & Signature	

Project Testing Schedule	
Schedule agreed by	Frequency
Testing Methodology	The testing method will be:
Drug Testing	Drug testing will be conducted on a frequency of: Random: Blanket:
Alcohol Testing	Blood Alcohol Content will be conducted on a frequency of: Random: Blanket:

Record of Testing Completed		
Test Date	Type of Test	Tested By

APPENDIX H – Living Away From Home Allowance

1.1 Qualification

- (a) An Employee shall be entitled to the provisions of this clause when employed on a job or construction work at such a distance from the Employees' usual place of residence that the employee cannot reasonably return to that place each night under the following conditions:
 - (i) The Employee is not in receipt of relocation benefits.
 - (ii) The Employee is maintaining a separate place of residence to which it is not reasonable to expect the employee to return each night; and
 - (iii) The Employee on being requested by the employer informs the employer, at the time of engagement, that the Employee maintains a separate place of residence from the address recorded on the job application.
- (b) Subject to **clause 1.111.1(a)(iii)** hereof an employee is regarded as bound by the statement of the employees' address and no entitlement shall exist if unknowingly to the employer the employee wilfully and without duress made a false statement in relation to the above.

1.2 Employee's address

- (a) The employer shall require and the applicant shall provide the employer with the following information, in writing, at the time of engagement:
 - (i) the address of the place of residence at the time of application; and
 - (ii) the address of the separately maintained residence, if applicable.
- (b) Provided however, that the Employer shall not exercise undue influence, for the purpose of avoiding its obligations under the Award, in persuading the prospective employee to insert a false address.
- (c) No subsequent change of address shall entitle an employee to the provisions of this clause unless the employer agrees.
- (d) Documentary proof of address such as a long service leave registration card or driver's licence may be accepted by an employer as proof of the employee's usual place of residence.
- (e) The address of the employee's usual place of residence and not the place of engagement shall determine the application of this clause.
- (f) Any dispute arising in respect of this clause shall be dealt with in accordance with clause 10 disputes resolution procedure of this Agreement.
- (g) The Employer shall not in any way attempt to influence or persuade an Employee to provide a false address for the purposes of this clause.

1.3 Entitlement

Where an employee qualifies under **clause 1.111.1** of this Appendix the Employer shall:

- (a) pay an allowance of \$913.75 per week of seven days but such allowance shall not be wages. In the case of broken parts of the week occurring at the beginning or the ending of the employment on a distant job the allowance shall be \$180.75 per day.

Provided that the foregoing allowances shall be increased if the employee satisfies the employer that the employee reasonably incurred a greater outlay than that prescribed. In the event of disagreement the matter may be dealt with in accordance with **clause 11** – Disputes resolution procedure of this agreement. In addition, \$13.95 shall be paid for each night the employee is required to be away from home; or

- (b) provide the Employee with reasonable board and lodging (**reasonable board and lodging** shall mean lodging in a well kept establishment with three adequate meals each day, adequate furnishings, good bedding, good floor coverings, good lighting and heating with hot and cold running water, in either a single room or twin room if a single room is not available), or
- (c) For projects tendered after the Commencement of Agreement, provide the Employee with reasonable board and lodging except that instead of providing meals the Employer may pay \$75.00 per day for meal expenses and a further \$12.00 for each night the employee is required to be away from home.

1.4 Travelling expenses

An employee who is sent by an employer or selected or engaged by an employer or agent to go to a job which qualifies the employee to the provision of this clause shall not be entitled to any of the allowances prescribed by **clause** Error! Reference source not found. of this Agreement for the period occupied in travelling from the employees' usual place of residence to the distant job, but in lieu thereof shall be paid:

- (a) Forward journey
 - (i) The time spent in travelling, at the Ordinary Rate up to a maximum of eight hours per day for each day of travel (to be calculated as the time taken by rail or the usual travelling facilities).
 - (ii) The amount of a fare on the most common method of public transport to the job (bus; economy air; second class rail with sleeping berths if necessary, which may require a first class rail fare), and any excess payment due to transporting tools if such is incurred.
 - (iii) Any meals incurred while travelling at the rate of meal allowance as stipulated at **clause 38** of the Agreement.
 - (iv) Provided that the employer may deduct the cost of the forward journey fare from an employee who terminates or discontinues employment within two weeks of commencing on the job and who does not forthwith return to the employee's place of engagement.
- (b) Return journey
 - (i) An employee shall, for the return journey, receive the same time, fares and meal payments as provided in **clause 1.111.4(a)** of this Appendix, together with an amount of \$24.30 to cover the cost of

transport and transporting tools from the main public transport terminal to the employees usual place of residence. Subject to further order this allowance shall not be payable to employees engaged on weekly hire.

- (ii) Provided that the above return journey payments shall not be paid if the employee terminates or discontinues employment within two months of commencing on the job or is dismissed for incompetence within one working week of commencing on the job, or is dismissed for misconduct.

- (c) Departure point

For the purpose of this clause, travelling time shall be calculated as the time taken for the journey from the Central or Regional rail, bus or air terminal nearest the employee's usual place of residence to the locality of the work.

1.5 Daily fares allowance

An employee engaged on a job who qualifies under the provisions of this clause and who is required to reside elsewhere than on the site (or adjacent to the site and supplied with transport) shall be paid the allowance prescribed by **clause 26** of this Agreement.

1.6 Weekend return home

- (a) An employee who works as required during the ordinary hours of work on the working day before and the working day after a weekend and who notifies the employer or employers representative, no later than Tuesday of each week, of the employees intention to return to the employees usual place of residence at the weekend and who returns to such usual place of residence for the weekend, shall be paid an allowance of \$41.10 for each occasion provided that the Employee does not miss any ordinary hours of work other than genuine absences for paid leave e.g. due to illness/caring responsibilities etc..
- (b) **Clause 1.111.6(a)** hereof shall not apply to an employee who is receiving the payment prescribed in **clause 1.111.3(a)** hereof in lieu of board and lodging being provided by the employer.
- (c) When an employee returns to the employees usual place of residence for a weekend or part of a weekend and is not absent from the job for any of the ordinary working hours, no reduction of the allowance prescribed in **clause 1.111.3(a)** hereof shall be made.

1.7 Alternative paid day off procedure

If the employer and the employee so agree in writing, the paid rostered day off as prescribed in **clause 37** - Rostered Days Off of this agreement, may be taken, and paid for at the end of the project, or on termination whichever comes first.

1.8 Termination

An employee shall be entitled to notice of termination in sufficient time to arrange suitable transport at termination or shall be paid as if employed up to the end of the ordinary working day before transport is available.

1.9 CPI movements

The amounts prescribed by this clause will be adjusted annually in accordance with CPI (All Groups, Melbourne) movements measured in the twelve month period ending the previous December quarter effective as of 1 March from 2025 onwards, rounded to the nearest five (5) cents.

**APPENDIX I – Notification Form Pursuant to Clause 37.8(c) to
Work on Scheduled RDO**

Date:

Employer:	
Date of scheduled RDO to be Worked:	
Project Name:	
Project Address:	
Work to be Undertaken:	
Approximate Number of Employees required:	
Union Delegate/ Employee Representative (if applicable)	
Manager Contact Details:	
Name:	
Phone:	Fax:

Tick the appropriate box:

- £ Affected Employee/s consulted by Employer.
- £ Affected Employee/s not wishing to work in accordance with the clause have been given opportunity to reasonably refuse.
- £ Affected Employee/s informed that if they have a concern about working the scheduled RDO they can raise the matter with their Union Delegate/ Employee representative.

Reason/s for work on scheduled RDO (as per clause 37 of the Agreement)

- £ Allow others to work productively
- £ Maintenance, repair, commissioning
- £ Unforeseen delays
- £ Inclement weather
- £ Unexpected delays, scheduling, supplies
- £ Restrictions, laws, regulations, etc.

Explanation of ground/s listed above:

APPENDIX J – Sexual Harassment Principles

Gendered violence causes physical and psychological harm and poses significant risk to the health, safety and wellbeing of the workers. Gendered violence is any behaviour that causes harm to a worker because of their sex, gender or sexual orientation.

1 SEXUAL HARASSMENT

1.1 Purpose

Sexual harassment is unlawful and prohibited by both the *Equal Opportunity Act 2010* (Vic) and the *Sex Discrimination Act 1984* (Cth).

The Parties are committed to providing a safe, flexible and respectful environment for all employees free from all forms of sexual harassment.

1.2 Principles

The principles associated with this provision are that:

- Sexual harassment is unlawful and will not be tolerated in the workplace.
- A single incident can constitute sexual harassment.
- Employees may be personally liable if allegations of sexual harassment are substantiated against them.
- Legal action (civil and/or criminal) may be taken against a person who has engaged in sexual harassment.
- The Parties recognises that comments and behaviour that do not offend one person can offend another. All employees are required to treat others with dignity, courtesy and respect.

1.3 Responsibilities

Employees

All Employees must:

- not engage in sexual harassment;
- participate in any training provided by the Employer;
- treat information in relation to claims of sexual harassment with confidentiality;
- ensure that a person is not victimised for making, or being involved in, a sexual harassment complaint; and
- report any observations of suspected or alleged sexual harassment in accordance with this Policy.

Employer

The Employer will treat all complaints seriously and take prompt and appropriate action to address them in accordance with this Policy.

2 SEXUAL HARASSMENT IN THE WORKPLACE

1.1 What is sexual harassment?

Sexual harassment in the workplace may take various forms and can be directed at, and perpetrated by, all persons including male, female, transgender and gender diverse. It may be physical, spoken or written and may include, but is not limited to unwelcome:

- physical contact of a sexual nature;
- comments or questions of a sexual nature about a person's private life or their appearance;
- sexually suggestive behaviour, such as leering or staring or offensive gestures;
- brushing up against someone, touching, fondling or hugging;
- sexually suggestive comments or jokes;
- displaying offensive screen savers, photos, calendars or objects;
- repeated requests to go out;
- unwanted displays or declarations of affection;
- requests for sex;
- sexually explicit emails, text messages or posts on social networking sites;
- sexual assault, indecent exposure, physical assault and stalking (which are also criminal offences); and
- actions or comments of a sexual nature in a person's presence (even if not directed at that person).

1.2 Threshold

The *Equal Opportunity Act 2010* and the *Sex Discrimination Act 1984* provide that sexual harassment occurs in circumstances in which the conduct is unwelcome and where a reasonable person, having regard to all the circumstances, would have anticipated that the other person would be offended, humiliated or intimidated.

There is no requirement that the unwelcome conduct be repeated; a one-off incident can be sexual harassment. Equally, a broader pattern of behaviour can constitute sexual harassment.

1.3 What is the workplace?

Within the workplace

For the purposes of sexual harassment law, a workplace is any place a person attends for the purpose of carrying out functions in connection with, or in the course of their employment or prospective employment. This includes work performed at your designated site as well as attendance at work related events and functions.

3 REPORTING SEXUAL HARASSMENT

The Parties will not stand for any form of sexual harassment in the workplace. The Parties strongly encourages employees who believe they have been sexually harassed or have witnessed sexual harassment to consider making an informal or formal complaint.

In cases of sexual assault, employees will be invited to make a report to the police.

1.1 Confidentiality

Disclosures/complaints of sexual harassment will be treated in confidence in order to protect an employee's personal privacy as much as possible.

4 RESPONDING TO SEXUAL HARASSMENT

1.1 Employer's responsibility

If a complaint of sexual harassment is made, or sexual harassment is observed or brought to the attention of the Employer it must be acted upon, as appropriate, as soon as practicable. When considering the report of sexual harassment the complainant and respondent will be:

- treated fairly and respectfully; and
- allowed the opportunity to respond to any allegations made against them before any final decision is made.

1.2 Findings

A substantiated complaint of sexual harassment may result in a number of outcomes against an employee, including termination of employment. Depending on the severity of the case, actions following a finding of sexual harassment can range from an apology to disciplinary action against the person found to have engaged in harassment (such as demotion, transfer or termination of employment).

Each case will be assessed on its own merits.

APPENDIX K – Flexible Working Arrangement Request Form

<Date>

Private and confidential

Employee details:

<Your name>

<Contact details>

<Job title>

Dear <insert manager's name>

Request for flexible working arrangements

I would like to request under section 65 of the *Fair Work Act 2009* (the Act) to work a flexible work arrangement that is different to my current working arrangement.

I am making this request

<to help me care for a child who is under school age/school age>

<because I am pregnant>

<because I am a carer (within the meaning of the *Carer Recognition Act 2010*)>

<because I am 55 or older>

<because I have a disability>

<because I am experiencing violence from a member of my family>

<to help me to provide care or support to a member of my immediate family or a member of my household who is experiencing violence from their family>.

Include whichever of the above statements applies to you and delete the other options.

I can confirm that I have worked continuously as an employee of this business for the last 12 months and am employed on a <full time basis/part time basis/casual basis on a regular and systemic basis>.

Include whichever of the above employment statuses applies to you and delete the other options.

I would like to start working <include a paragraph to describe the working pattern you would like to have in the future including the days/hours/times you would like to work>.

These changes will assist me because <insert reasons>.

I would like this working arrangement to start from <insert date>.

I believe that the effect on the business and my colleagues can be accommodated by <identify ways the work can be performed, how your proposal may help the business or how you are committed to working hard to make the arrangements work well>.

I would appreciate your response to this request, in accordance with the Act, within 21 days of today's date.

I am happy to discuss this matter at a time that is convenient. I am willing to discuss possible alternatives to the arrangements I have outlined and I am also willing to work

with you to make sure that this arrangement works effectively for both the business and me. Please contact <me/my representative> on <insert contact details>.

Yours sincerely,

<Insert name>

APPENDIX L – Sham Contracting Compliance Checklist



Sham contacting: Compliance checklist

This checklist is provided to help principal contractors and subcontractors make a preliminary self-assessment of their compliance with various laws relating to visas and sham contracting. If the contractor is in doubt about its compliance with any Australian law, it should obtain independent legal advice.

It is best practice for principal contractors to provide this checklist to subcontractors as part of the engagement process each time a contractor is engaged.

Principal contractors should periodically use this checklist to ensure continuing compliance with legal obligations.

A. Sham contracting and visas

Yes No

- 1) Does your organisation have policies, procedures, plans or systems in place to help you meet your legal obligations to ensure:
- workers have a legal right to work in Australia
 - the avoidance of sham contracting

For principal contractors only:

- 2) Does your organisation:
- investigate substantial price differences identified in the tender phase, and commit to investigate all pricing to ensure employees and subcontractors are engaged legally
 - have monitoring and auditing processes set out in management plans and company quality systems
 - require a statutory declaration for progress payments that demonstrates compliance with relevant legal obligations

B. Compliance with legal obligations

Yes No

- 1) Does your organisation have policies, procedures, plans or systems to ensure compliance with the following legislation:
- Commonwealth workplace relations legislation (including the **Building and Construction Industry (Improving Productivity) Act 2016 (Cth)** and where applicable the **Code for the Tendering and Performance of Building Work 2016** and the **Fair Work Act 2009 (Cth)**)

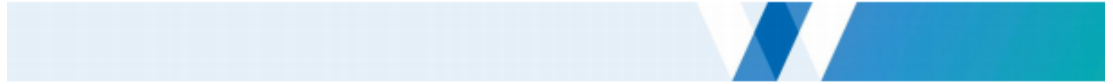

B. Compliance with legal obligations (cont.) Yes No

- Long service leave (including the **Construction Industry Long Service Leave Act 1997 (Vic)** and **Long Service Leave Act 2018 (Vic)**)
- Labour hire laws (including the **Labour Hire Licensing Act 2018 (Vic)**)
- Occupational health and safety (including the **Occupational Health and Safety Act 2004 (Vic)**)
- Workers compensation (including the **Workplace Injury Rehabilitation and Compensation Act 2013 (Vic)**)
- Superannuation law (including the **Superannuation Guarantee Administration Act 1992 (Cth)**)
- Immigration law (including the **Migration Act 1958 (Cth)**)

C. Managing employee entitlements Yes No

- 1) Does your organisation only employ employees in accordance with an enterprise agreement approved by the Fair Work Commission, modern award or employment contract?
 - 2) Does your organisation have policies, procedures, plans or systems in place that allow employees to access information about the relevant enterprise agreement or modern award?
 - 3) In the past 24 months, has your organisation made the following payments relating to minimum wages and employment conditions?
 - wages, including penalty rates, overtime and casual rates
 - allowances
 - annual leave
 - long service leave
 - superannuation
 - workers compensation insurance
 - other lawful payments that are specified in a modern award or enterprise agreement, for example, payments made to redundancy funds
 - 4) In the past 24 months, has your organisation been subject to any proceeding or findings against it by a court or tribunal for sham contracting?
-



D. Visa compliance

Yes No

- | | | |
|---|--------------------------|--------------------------|
| 1) Does your organisation have policies, procedures, plans or systems in place to ensure compliance with legal obligations when engaging employees who have a working visa? | <input type="checkbox"/> | <input type="checkbox"/> |
| 2) Does your organisation have the policies, procedures, plans or systems in place to ensure: | <input type="checkbox"/> | <input type="checkbox"/> |
| ▪ Visa Entitlement Verification Online system (VEVO) checks are carried out by recruitment teams before the engagement and induction of all employees | | |
| ▪ commercial contracts contain measures to ensure the obligation for visa compliance is passed down the contractual chain | | |
| ▪ contractual measures are in place to oblige subcontractors to notify the principal contractor of visa non-compliance | | |
| ▪ appropriate compliance training is in place for recruitment teams and hiring managers | | |
| ▪ processes are in place to monitor and audit contractors' management of visa compliance | | |
| ▪ record-keeping and document management systems are in place to store employee visa details | | |
| 3) In the past 24 months, has your organisation been subject to any proceedings or findings against it in respect of a breach of migration laws? | <input type="checkbox"/> | <input type="checkbox"/> |

E. Managing contractors

Yes No

- | | | |
|---|--------------------------|--------------------------|
| 1) If your organisation contracts part or all of its scope of work to a third party, does your organisation ensure that relevant contractual documentation, arrangements or agreements require that party to comply with their legal obligations? | <input type="checkbox"/> | <input type="checkbox"/> |
| For principal contractors only: | | |
| 2) Are your subcontractors required to notify you as the principal contractor of a dispute concerning allegations of sham contracting? | <input type="checkbox"/> | <input type="checkbox"/> |

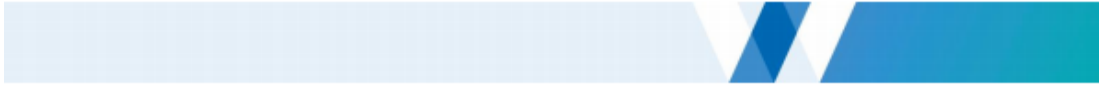

Statement of non-compliance

If you have answered 'No' to any of the above questions, provide a detailed explanation of the extent of non-compliance and remedial actions that will be taken.

Criteria

A

B

C

D

E

For subcontractors only:

Signed on behalf of _____

Date:

APPENDIX M – Preserved Award Allowances

- 1.1 The allowances and special rates in Appendix M will be adjusted annually in accordance with CPI (All Groups, Melbourne) movements measured in the twelve month period ending the previous December quarter effective as of 1 March from 2025 onwards, rounded to the nearest cent.

General Wage Related Allowances

1.2 Refractory bricklaying allowance

- (a) A special allowance to compensate for disabilities associated with the work of refractory bricklaying must be paid as follows:

Classification	Per hour \$
Refractory bricklayer	2.75
Refractory bricklayer's assistant	2.34

- (b) This allowance must be paid instead of all special rates prescribed in clauses 1.6 to 1.8, except clauses 1.6(b) and 1.6(c) and will be regarded as part of the ordinary time hourly rate.
- (c) An apprentice Refractory bricklayer must be paid the allowance on a proportionate basis reflecting the appropriate percentage of the standard wage in clause 19.7 of the Award.

1.3 Cofferdam worker

- (a) Not under air pressure—Employees must be paid an additional \$17.76 per week;
- (b) Under air pressure—as agreed to between the Employer and Employees.

1.4 Air-conditioning industry and refrigeration industry allowances

- (a) In addition to the appropriate minimum wage prescribed in Appendix B – Wage rates, an air-conditioning tradesperson and a refrigeration mechanic must be paid a weekly allowance of \$82.53 as compensation for the various disabilities and peculiarities associated with on-site air-conditioning work or on-site refrigeration work.
- (b) An Employee in receipt of this allowance will not be entitled to special rates in:
- clause 1.6(a)—Insulation;
 - clause 1.6(b)—Hot work;
 - clause 1.6(c)—Cold work;
 - clause 1.6(d)—Confined space;
 - clause 1.6(g)—Wet work;

- clause 1.6(h)—Dirty work;
- clause 1.6(l)—Asbestos eradication; and
- clause 1.6(q)—Height work.

Special rates

1.5 Conditions in respect of special rates

- (a) The special rates prescribed in this appendix must be paid irrespective of the times at which work is performed and will not, except where specified, be subject to any premium or penalty conditions.
- (b) This limitation does not apply to the all purpose special rates prescribed in clauses 1.6(m) and 1.6(n).
- (c) Where more than one of the special rates provides payments for disabilities of substantially the same nature, then only the highest of such rates will be payable unless otherwise provided.
- (d) The special rates must be paid to Employees in addition to the other rates in this Agreement.

1.6 Special rates applicable to all sectors

(a) Insulation

An Employee handling charcoal, pumice, granulated cork, silicate of cotton, insulwool, slag wool, limpet fibre, vermiculite, or other recognised insulating material of a like nature, associated with similar disabilities in its use, must be paid an additional \$1.06 per hour or part thereof. This extra rate will also apply to an Employee working in the immediate vicinity who is affected by the use of such materials.

(b) Hot work

- (i) An Employee who works in a place where the temperature has been raised by artificial means to between 46 degrees and 54 degrees Celsius must be paid an additional \$0.85 per hour or part thereof. In temperatures exceeding 54 degrees Celsius, an Employee must be paid an additional \$1.06 per hour or part thereof.
- (ii) Where such work continues for more than two hours, the Employee will be entitled to 20 minutes rest after every two hours work without loss of pay, not including the special rate provided by this subclause.

(c) Cold work

An Employee who works in a place where the temperature is lowered by artificial means to less than 0 degrees Celsius must be paid an additional \$0.85 per hour. Where such work continues for more than two hours, the Employee will be entitled to 20 minutes rest after every two hours work without loss of pay, not including the special rate provided by this subclause.

(d) Confined space

- (i) An Employee required to work in a confined space must be paid an additional \$1.06 per hour or part thereof.

- (ii) Confined space means a place the dimensions or nature of which necessitate working in a cramped position or without sufficient ventilation.

(e) Swing scaffold

- (i) An Employee required to work from any type of swing scaffold or any scaffold suspended by rope or cable, bosun's chair, or a suspended scaffold requiring the use of steel or iron hooks or angle irons must be paid the appropriate allowance set out below corresponding to the storey level at which the anchors or bracing, from which the stage is suspended, have been erected. The allowance must be paid for a minimum of four hours' work or part thereof until construction work has been completed.

Height of bracing	First four hours	Each additional hour
0–15 storeys	\$6.16	\$1.27
16–30 storeys	\$7.95	\$1.67
31–45 storeys	\$9.40	\$1.90
46–60 storeys	\$15.40	\$3.18
greater than 60 storeys	\$19.64	\$4.08

- (ii) An apprentice with less than two years' experience must not use a swing scaffold or bosun's chair, and further provided that solid plasterers when working off a swing scaffold must receive an additional \$0.18 per hour.
- (iii) Payments contained in this subclause are in recognition of the disabilities associated with the use of swing scaffolds.
- (iv) For the purposes of this clause:
- completed means the building is fully functional and all work which is part of the principal contract is complete;
 - storeys will be given the same meaning as a storey level in the Award.

(f) Explosive powered tools

An operator of explosive powered tools, who is required to use an explosive powered tool, must be paid an additional \$2.00 for each day on which the Employee uses such a tool.

(g) Wet work

An Employee working in any place where water is continually dripping such that clothing and boots become wet, or where there is water underfoot, must be paid an additional \$0.85 per hour whilst so engaged.

(h) Dirty work

An Employee engaged on unusually dirty work must be paid an additional \$0.85 per hour.

(i) Toxic substances

- (i) Employees using toxic substances or materials of a like nature must be paid an additional \$1.06 per hour. Employees working in close proximity to Employees so engaged must be paid an additional \$0.85 per hour.
- (ii) Toxic substances include epoxy based materials and all materials which include or require the addition of a catalyst hardener and reactive additives and include a two pack catalyst system.

(j) Fumes

An Employee required to work in a place where fumes of sulphur or other acid or other offensive fumes are present must be paid an allowance which will be such rates as are agreed upon between the Employee or the majority of Employees and the Employer.

(k) Asbestos

Employees required to wear protective equipment (i.e. combination overalls and breathing equipment or similar apparatus) as part of the necessary safeguards as required by the appropriate occupational health authority for the use of materials containing asbestos or to work in close proximity to Employees using such materials, must be paid an additional \$1.06 per hour whilst wearing such equipment.

(l) Asbestos eradication

Employees engaged in the process of asbestos eradication (defined as work on or about buildings involving the removal or any other method of neutralisation of any materials which consist of or contain asbestos) on the performance of work within the scope of this Agreement, must receive an additional \$2.84 per hour worked, but will not be paid special rates prescribed in this clause with the exception of:

- clause 1.6(b)—Hot work;
- clause 1.6(c)—Cold work;
- clause 1.6(e)—Swing scaffold;
- clause 1.6(d)—Plaster or composition spray;
- clause 1.6(h)—Second-hand timber; and
- clause 1.6(n)—Acid work.

(m) Furnace work

An Employee engaged in the construction of, or alteration or repairs to, boilers, flues, furnaces, retorts, kilns, ovens, ladels, and similar refractory work must be paid an additional \$2.25 per hour. This additional rate will be regarded as part of the ordinary time hourly rate for all purposes.

(n) Acid work

An Employee required to work on the construction of or repairs to acid furnaces, acid stills, acid towers and all other acid resisting brickwork must be paid an additional \$2.25 per hour. This additional rate will be part of the ordinary time hourly rate for all purposes.

(o) Heavy blocks—Employees laying other than standard bricks

- (i) Employees employed laying blocks (other than concrete blocks for plugging purposes) must be paid the following additional rates:
- where the blocks weigh over 5.5 kg and under 9 kg—\$0.85 per hour;
 - where the blocks weigh 9 kg to 18 kg—\$1.54 per hour;
 - where the blocks weigh over 18 kg—\$2.16 per hour.
- (ii) This special rate will not apply to Employees being paid the extra rate for refractory work.
- (iii) Stonemasonry Employees not provided with mechanical means for the handling, lifting and placing of heaving blocks will be paid the rates prescribed in this clause.

(p) Bitumen work

An Employee handling hot bitumen or asphalt or dipping materials in creosote, must be paid an additional \$1.06 per hour.

(q) Height work

An Employee, other than an Employee working on a bosun's chair or swinging stage, working on any structure at a height of more than nine metres where an adequate fixed support not less than 0.75 metres wide is not provided, must be paid an additional \$0.81 per hour. This provision does not apply in addition to the towers allowance prescribed in clause 1.7(a).

(r) Suspended perimeter work platform

- (i) This allowance applies to Employees engaged on construction work (including renovation or refurbishment work) performed on a suspended perimeter work platform (other than a swinging stage or bosun's chair) which uses a mechanical, hydraulic or other form of propulsion (not being rope or cable suspended) to relocate the work platform at different levels on the perimeter of a building or structure. An example of this type of system includes the Lubeca Façade System.
- (ii) The allowance payable is an additional \$1.34 per hour and is to be paid instead of swing scaffold and multistorey allowance for all Employees working on suspended perimeter work platform systems.

(s) Employee carrying fuels, oils and greases

An Employee required by the Employer to carry any fuels, oils and/or greases in the Employees own vehicle for use in the Employer's plant must be paid an additional \$14.06 per day in addition to any amount payable under **clause 26.6** of the Agreement—Daily fares and travel pattern allowance, for each day the Employee is so required by the Employer to carry such materials.

(t) Pile driving

Where a mobile crane in excess of 15 tonnes is required to perform pile driving at any site or installation, or is required to be involved in the extraction process, the operator must receive an additional \$20.07 per day or part thereof.

(u) Dual lift allowance

Where two or more forklifts or cranes are engaged on any lift the drivers thereof must be paid an additional \$4.29 for each day or part thereof so occupied.

(v) Stonemasons—cutting tools

If cutting tools are not provided the Employer must pay an additional \$0.05 per hour.

1.7 Special rates applicable only to the general building and construction sector

(a) Towers allowance

(i) An Employee working on a chimney stack, spire, tower, radio or television mast or tower, air shaft (other than above ground in a multistorey building), cooling tower, water tower or silo, where the construction exceeds 15 metres in height must be paid for all work above 15 metres, an additional \$0.85 per hour with \$0.85 per hour additional for work above each additional 15 metres.

(ii) Stonemasonry Employees not provided with mechanical means for the handling, lifting and placing of heaving blocks must be paid the rates prescribed in clause 1.6(o).

(b) Cleaning down brickwork

An Employee required to clean down bricks using acids or other corrosive substances must be paid an additional \$0.78 per hour.

(c) Bagging

Employees engaged upon bagging brick or concrete structures must be paid an additional \$0.78 per hour.

(d) Plaster or composition spray

An Employee using a plaster or composition spray must be paid an additional \$0.85 per hour whilst so engaged.

(e) Slushing

An Employee engaged in slushing must be paid an additional \$0.85 per hour.

(f) Dry polishing of tiles

Employees engaged on dry polishing of tiles where machines are used must be paid an additional \$1.06 per hour or part thereof.

(g) Cutting tiles

An Employee engaged at cutting tiles by electric saw must be paid an additional \$1.06 per hour whilst so engaged.

(h) Second-hand timber

Where, whilst working with second-hand timber, an Employee's tools are damaged by nails, dumps or other foreign matter on the timber the Employee will be entitled to an allowance of \$3.33 per day on each day upon which the Employee's tools are so damaged. No allowance will be payable under this clause unless it is reported immediately to the Employer's representative on the job in order that they may prove the claim.

(i) Roof repairs

Employees engaged on repairs to roofs must be paid an additional \$1.06 per hour, provided that instead of this rate roof slaters and tilers must be paid in accordance with the following:

- (i) An Employee who works on a roof at a height of over 15 metres measured at the loading point of the tiles at ground level to the eaves, must be paid an additional \$0.78 per hour.
- (ii) An Employee who works on a roof at a height of over 15 metres measured at the loading point of the tiles at ground level to the eaves and the pitch of which is over 35 degrees or over 40 degrees must be paid the sum of \$1.06 and \$1.54 respectively, rather than the allowance in **clause 1.7(i)(i)**.

(j) Grindstone allowance

An allowance of \$9.03 per week must be paid to each carpenter or joiner where a grindstone or wheel is not made available.

(k) Brewery cylinders—painters

- (i) A painter in brewery cylinders or stout tuns must be allowed a 15 minute spell in the fresh air at the end of each hour worked. Such 15 minutes will be counted as working time and will be paid for as such.
- (ii) The rate for working in brewery cylinders or stout tuns will be at the rate of time and a half. When an Employee is working overtime and is required to work in brewery cylinders and stout tuns the Employee must, in addition to the overtime rates payable, be paid one half of the ordinary time hourly rates.

(l) Spray application—painters

An Employee engaged on all spray applications carried out in other than a properly constructed booth, approved by the appropriate certifying authority, must be paid an additional \$0.85 per hour.

(m) Pneumatic tool operation

A stonemason using pneumatic tools of 2.75 kilograms or over in weight must be paid an additional \$4.65 each day on which the Employee uses such a tool.

(n) Bricklayer operating cutting machine

One bricklayer on each site is to operate the cutting machine and must be paid an additional \$1.06 per hour or part thereof while so engaged.

(o) Hydraulic hammer

An operator of a hydraulic hammer attached to an excavator must be paid an additional \$1.43 per hour for all purposes.

(p) Waste disposal

Plant operators working in landfill and garbage tips must be paid an additional \$1.85 per hour for each hour worked with a minimum payment of three hours each day. This allowance compensates for the special disabilities associated with the offensive and obnoxious nature of the duties of solid and liquid waste and garbage disposal. The allowance will be paid for each hour the Employees are suffering the disabilities and will not form part of the ordinary wage for all purposes of the Agreement.

1.8 Special rates applicable only to the civil construction sector

(a) Pipe enamelling

An Employee engaged on the enamelling of pipe joints by hand, on-site, must be paid an additional \$9.40 per day or part thereof.

(b) Powdered lime dust

- (i) Employees exposed for any period greater than one hour in any shift to powdered lime dust from the spreading or mixing of powdered lime used in the stabilisation of road making material must be reimbursed the cost of purchasing the following protective clothing:
 - overalls;
 - wide vision goggles;
 - respirator;
 - boots; and
 - gloves.
- (ii) The provisions of this subclause do not apply where the protective clothing is supplied by the Employer.
- (iii) In addition, the Employer must maintain at or near the work site or other place where such lime is being used, adequate facilities to enable any Employee whose skin is contaminated with lime either directly or through their ordinary clothing to wash the affected area. A supply of barrier cream and hand cleanser must be provided for the use of any Employee required to handle powdered lime.
- (iv) Employees engaged in carrying out lime work will be obliged to wear the protective clothing supplied by the Employer.
- (v) Each Employee exposed to powdered lime dust whilst engaged in spreading or mixing powdered lime must, during the time they are so exposed, be paid an additional \$0.96 per hour in addition to all other rates payable in this Agreement.

(c) Sand blasting

An Employee required to use a sand blasting machine must be paid an additional \$1.05 per hour or part of an hour whilst so engaged.

(d) Live sewer work

An Employee who works in a situation where there is direct aerial connection with a sewer through which sewerage is flowing, must be paid an additional \$0.11 per hour.

(e) Timbering

Any sinker required to timber any shaft, drive or trench must be paid an additional \$0.99 per hour or part thereof.

(f) Special work

A driver operating a tractor fitted with a blade and using such blade in breaking trail in heavy sidling country must be paid an additional \$0.11 per hour for each day or part of a day when so occupied.

(g) Compressed air work

Employees engaged in construction work in compressed air must be paid the following special rates:

Gauge reading	Rate per hour worked and spent in compression and decompression
0 to 35 kPa	\$1.90
Over 35 and up to 65 kPa	\$2.39
Over 65 and up to 100 kPa	\$4.84
Over 100 and up to 170 kPa	\$9.62
Over 170 and up to 225 kPa	\$16.03
Over 225 and up to 275 kPa	\$30.72

(h) Cutting stone

An Employee engaged at cutting stone, blocks and bricks by power saw will be paid an additional \$1.06 per hour or part thereof.

APPENDIX N – Respect Code

Respect Code – Building and Construction Industry

Building Industry Consultative Council

The foundation for a safe and inclusive industry

A positive work environment is one where everyone feels safe, appreciated, respected, and valued. Everyone has a right to a workplace free from bullying, sexual harassment and discrimination.

The Respect Code - Building and Construction Industry (Respect Code) is:

- An industry-led initiative developed by the Building Industry Consultative Council (BICC) which includes leaders from employer associations, unions, major construction companies and Victorian government.
- Modelled on the provisions of enterprise agreements in the building and construction industry which now include a Safe and Respectful Workplaces provisions.
- Supports making this industry a better place to work for women.

Respect is a fundamental right of every woman in the building industry

- It means women are equal.
- It lets women know they are valued for their abilities, qualities and achievements.
- It requires the elimination of unacceptable behaviour.

Objectives

This Respect Code will:

- Ensure everyone understands their legal obligations under occupational health and safety, bullying, sexual harassment and discrimination laws.
- Create lasting behavioural change by empowering people to create and maintain respectful workplaces.
- Demonstrate to women that this industry values their involvement.
- Strive to eliminate unacceptable behaviour.

Principles

This Respect Code was developed in collaboration with industry stakeholders and guided and informed by the views of women who work in the building and construction industry.

Implementing it will assist in creating safe and respectful workplaces for women where safety, inclusiveness and wellbeing are paramount.



Responsibilities

Everyone is responsible for ensuring their actions and behaviours reflect the principles in this Respect Code.

We should always:

- Ensure everyone is treated equally.
- Treat each other with consideration and respect.
- Be inclusive and promote teamwork.
- Value others and accept their differences.
- Consider the impact of our behaviours on the women we work with.
- Call out behaviour that could lead to bullying, work-related gendered violence including sexual harassment or discrimination.
- Acknowledge that our own behaviours and attitudes contribute to a respectful work environment.

Employers must have a Respect Code in the workplace. Every employer:

- Has legal responsibility across all stages of employment.
- Must have policies and processes in place to ensure they are meeting their legal obligations under occupational health and safety, bullying, sexual harassment and discrimination laws.
- Must ensure women's rights are respected across all stages of employment, including recruitment, career training and progression, before, during and after parental leave and carer's leave.
- Must have a bullying, sexual harassment and discrimination training program to educate all employees on their legal obligations and rights at work. The training may range from worksite inductions to specific training for leaders and representatives.

Managers must set the example and standards for everyone to follow. Every manager on a project must:

- Set clear expectations of respectful behaviour and respond to ideas, concerns, complaints and feedback with fairness and respect.
- Ensure the Respect Code is understood by everyone working on each project and include information about the Respect Code in site inductions.
- Facilitate the nomination and training of at least one person on each project as a Contact Officer to provide information and support to workers. The Contact Officer will need to be adequately trained in issues including disclosure, responsible referral practices and work-related gendered violence.

Disrespectful, unacceptable, illegal and inappropriate behaviours

These behaviours will not be tolerated in the industry.

Bullying

Bullying is when a person or a group of people repeatedly acts unreasonably towards a worker or a group of workers. Bullying can include:

- Verbal abuse – spoken insults to, or about someone.
- Physical abuse – physically harming or threatening to harm someone.
- Written abuse – notes, emails, or posts on social media.
- Insulting or abusive graffiti.
- Exclusion or isolating someone.

Sexual Harassment

Sexual harassment is unwelcome behaviour of a sexual nature that causes a person to feel offended, humiliated, or intimidated. Sexual harassment includes:

- An unwelcome sexual advance.
- An unwelcome request for sexual favours.
- Any other unwelcome conduct of a sexual nature.

Sexual harassment can be physical, verbal or written, for example:

- Comments about someone's private life.
- Comments about the way someone looks.
- Sexually suggestive behaviour, such as leering or staring.
- Brushing up against someone, touching, fondling, or hugging.
- Sexually suggestive comments or jokes.
- Displaying offensive images or objects.
- Repeated requests to go out.
- Requests for sex.
- Sexually explicit emails, text messages or posts on social media.
- Sexual assault.

Sexual Discrimination

Sexual Discrimination is when women are treated less favourably than men. It includes:

- Refusal to employ.
- Deny rights to various forms of leave.
- Deliberate denial of opportunities to advance.
- Termination because of gender.

Construction Industry Respect Code

Women from culturally and linguistically diverse backgrounds

Women from culturally and linguistically diverse communities may experience compounded discrimination, disrespect and harassment on multiple grounds, for this reason, this Respect Code references respectful behaviours beyond gender. There are many activities and actions available to promote and ensure equity for women from all backgrounds.

Making a complaint

Complaints will be taken seriously

Any person reporting or making a complaint of bullying, work-related gendered violence including sexual harassment or discrimination to Project Management can expect

- The report or complaint to be treated seriously and any allegation to be treated with confidentiality.
- Access to policies and processes relating to complaints management, investigation and responses to any allegations.
- Support from Project Management.
- Formal investigation to be conducted according to the relevant company processes/procedures. If a matter is the subject of a formal investigation, at the end of an investigation, the person making the complaint and alleged offender should be advised of what action (if any) the Project Management proposes to take.

Additional Advice

- Project based Contact Officer(s) are to be available for anyone who needs advice or assistance. They will be trained appropriately in relevant legislation, including matters of privacy, disclosure, responsible referral practices and work-related gendered violence including sexual harassment.
- Complaints of bullying, work-related gendered violence including sexual harassment or discrimination by a person or a group of people from the same company must be made through the Employer.
- Complaints of bullying, work-related gendered violence including sexual harassment or discrimination by a person or a group of people from another company on site may be made through either the employee's own company or through Project Management.

Information about how to make a complaint will be made available through:

- The relevant Enterprise Bargaining Agreement or individual employment contract; and/or the company's policies, processes and systems.
- If an allegation involves assault or threats of assault, acts of violence, sexual assault, damage to property or stalking, a person or a group of people affected may contact Victoria Police.

Respect for women – Fair Work Act

To ensure workers are protected and empowered to address sexual harassment at work the Fair Work Act has been updated to:

- Introduce definitions of 'sexually harass' and 'sexually harassed at work'.
- Expand the anti-bullying jurisdiction of the Fair Work Commission to allow it to make orders to stop sexual harassment at work.
- Clarify that sexual harassment in connection with an employee's employment can be a valid reason for dismissal.

For more information, visit [Sexual harassment in the workplace](#)

Respect for women – occupational health and safety laws

Workplace Gendered Violence ¹ is a serious occupational health and safety issue. WorkSafe has developed a guide to help employers prevent and respond to work-related gendered violence.

Click here for a copy of the guide www.worksafe.vic.gov.au/work-related-gendered-violence-including-sexual-harassment

Power inequalities between women and men can result in gendered violence within the workplace. Gendered violence is actions and behaviours perpetrated against women because they are women. It can include any of the following comments and gestures:

- stalking, intimidation or threats,
- verbal abuse,
- ostracism or exclusion,
- sexually explicit gestures,
- offensive language and imagery,
- put downs, innuendo, and insinuations,
- being undermined in your role or position,
- sexual harassment,
- sexual assault or rape,

Employers, employees and others have specific duties relating to work-related gendered violence, including work-related sexual harassment under the Occupational Health and Safety Act (OHS Act) and the Equal Opportunity Act.

Under the OHS Act, employers must provide and maintain a work environment that is safe and without risk to the health of their employees, so far as is reasonably practicable

An effective way to eliminate the risk of gendered violence is to establish and maintain safe and inclusive workplace cultures and systems, where disrespect and incivility are not tolerated.

¹ **WorkSafe definition:** Work-related gendered violence is any behaviour, directed at any person, or that affects a person, because of their sex, gender or sexual orientation, or because they do not adhere to socially prescribed gender roles, that creates a risk to health and safety. This includes violence targeted directly at someone specifically because, for example:

- they are a woman
- they identify as LGBTIQ+
- they don't follow socially prescribed gender roles and stereotypes.

Work-related gendered violence can also be experienced indirectly. A person may experience gendered violence not targeted specifically at them (such as overhearing a conversation that affects them) or witness violence directed at someone else. Sexual harassment is a common form of gendered violence.

Construction Industry Respect Code



Further information

WorkSafe www.worksafe.vic.gov.au

Victorian Equal Opportunity and Human Rights Commission www.humanrights.vic.gov.au

Workplace Gender Equality Agency WGEA www.wgea.gov.au

Respect Victoria www.respectvictoria.vic.gov.au

Carlton Respects <https://carltonrespects.com.au>

Victorian Government Gender Equality Strategy www.vic.gov.au/our-gender-equality-strategy

Victorian Multicultural Commission [Victorian Multicultural Commission](#)

Fair Work Ombudsman [Respect at Work reforms | Fair Work Ombudsman](#)

APPENDIX O – Job Sharing Examples

Example One

Employee A and Employee B are job sharing a peggy role on a Project site. Employee A works Monday, Tuesday and Wednesday and Employee B works Thursday and Friday. Their working hours and pro-rata entitlements are shown in the tables below.

Employee A

	Hours Worked	Incolink (Redundancy)	Allowances
Monday	8.0	Pro Rata	Paid according to hours/days worked (daily allowances paid in full)
Tuesday	8.0	Pro Rata	Paid according to hours/days worked (daily allowances paid in full)
Wednesday	8.0	Pro Rata	Paid according to hours/days worked (daily allowances paid in full)
Thursday			
Friday			

Employee B

	Hours Worked	Incolink (Redundancy)	Allowances
Monday			
Tuesday			
Wednesday			
Thursday	8.0	Pro Rata	Paid according to hours/days worked (daily allowances paid in full)
Friday	8.0	Pro Rata	Paid according to hours/days worked (daily allowances paid in full)

Example Two

Employee C and Employee D are job sharing a peggy role on a project site. Employee C and Employee D both work Monday to Friday 4 hours per day. Their working hours and pro-rata entitlements are shown in the tables below.

Employee C

	Hours Worked	Incolink (Redundancy)	Allowances
Monday	4.0	Pro Rata	Paid according to hours/days worked (daily allowances paid in full)

CFMEU (Victorian Construction and General Division) Subcontractors Concrete Kerb,
Channel & Pavement Enterprise Agreement 2024-2027

Tuesday	4.0	Pro Rata	Paid according to hours/days worked (daily allowances paid in full)
Wednesday	4.0	Pro Rata	Paid according to hours/days worked (daily allowances paid in full)
Thursday	4.0	Pro Rata	Paid according to hours/days worked (daily allowances paid in full)
Friday	4.0	Pro Rata	Paid according to hours/days worked (daily allowances paid in full)

Employee D

	Hours Worked	Incolink (Redundancy)	Allowances
Monday	4.0	Pro Rata	Paid according to hours/days worked (daily allowances paid in full)
Tuesday	4.0	Pro Rata	Paid according to hours/days worked (daily allowances paid in full)
Wednesday	4.0	Pro Rata	Paid according to hours/days worked (daily allowances paid in full)
Thursday	4.0	Pro Rata	Paid according to hours/days worked (daily allowances paid in full)
Friday	4.0	Pro Rata	Paid according to hours/days worked (daily allowances paid in full)

Notes

If a Public Holiday falls on a non-working day the Employee will not be paid for that day.

Where an allowance is paid daily both Employee C and Employee D will be entitled to the full amount. For example, Fares and Travel Allowance.

Where an Employee works more than their agreed part time hours, they will be paid at overtime rates.